

# CP100

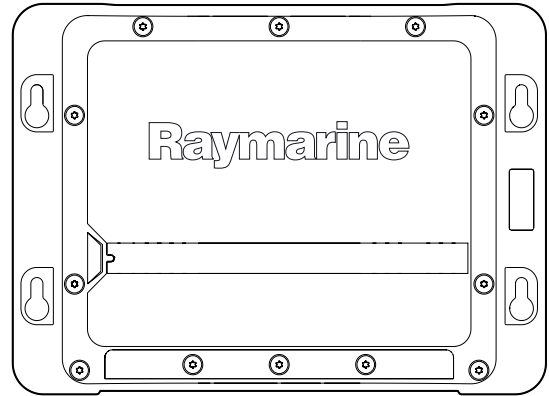

# SVSB

## Installation instructions

### English

Date: 07-2013

Document number: 87194-1-EN

© 2013 Raymarine UK Limited

SWIB

## Trademark and patents notice

Autohelm, hsb<sup>2</sup>, RayTech Navigator, Sail Pilot, SeaTalk, SeaTalk<sup>NG</sup>, SeaTalk<sup>HS</sup> and Sportpilot are registered trademarks of Raymarine UK Limited. RayTalk, Seahawk, Smartpilot, Pathfinder and Raymarine are registered trademarks of Raymarine Holdings Limited.

FLIR is a registered trademark of FLIR Systems, Inc. and/or its subsidiaries.

All other trademarks, trade names, or company names referenced herein are used for identification only and are the property of their respective owners.

This product is protected by patents, design patents, patents pending, or design patents pending.

## Fair Use Statement

You may print no more than three copies of this manual for your own use. You may not make any further copies or distribute or use the manual in any other way including without limitation exploiting the manual commercially or giving or selling copies to third parties.

## Software updates

Check the website [www.raymarine.com](http://www.raymarine.com) for the latest software releases for your product.

## Product handbooks

The latest versions of all English and translated handbooks are available to download in PDF format from the website [www.raymarine.com](http://www.raymarine.com). Please check the website to ensure you have the latest handbooks.

Copyright ©2013 Raymarine UK Ltd. All rights reserved.

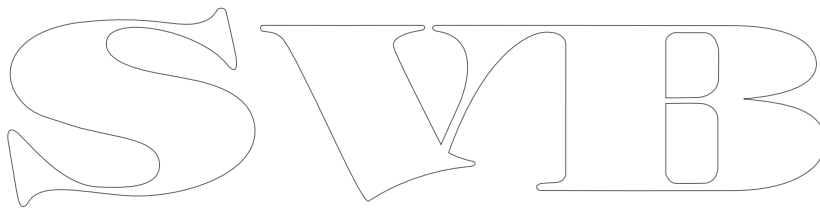
The image shows a large, stylized outline logo for 'SWIB'. The letters are interconnected and have a decorative, calligraphic feel. The 'S' is on the left, followed by 'W', 'I', and 'B' on the right. The entire logo is rendered in a simple black outline on a white background.

SWIB

# Contents

<b>Chapter 1 Important information.....</b>	<b>7</b>	10.3 Network cable connector types.....	45
Safety notices.....	7	10.4 Network cables .....	45
General Information .....	7	10.5 SeaTalk <sup>ng</sup> cables and accessories .....	46
<b>Chapter 2 Handbook and product information.....</b>	<b>9</b>		
2.1 Handbook information .....	10		
2.2 Product overview .....	10		
2.3 CHIRP Sonar overview.....	11		
2.4 CHIRP DownVision overview .....	11		
<b>Chapter 3 Planning the installation .....</b>	<b>13</b>		
3.1 Installation checklist .....	14		
3.2 Parts supplied.....	14		
3.3 Required additional components .....	15		
3.4 Compatible multifunction displays .....	15		
3.5 Compatible transducers.....	16		
3.6 Typical systems .....	16		
3.7 Tools .....	17		
<b>Chapter 4 Cables and connections.....</b>	<b>19</b>		
4.1 General cabling guidance .....	20		
4.2 Connections overview .....	20		
4.3 Power connection .....	21		
4.4 Transducer connection.....	22		
4.5 Network connection.....	23		
<b>Chapter 5 Location and mounting .....</b>	<b>25</b>		
5.1 Selecting a location.....	26		
5.2 Product dimensions.....	26		
5.3 Mounting .....	27		
<b>Chapter 6 System checks and troubleshooting .....</b>	<b>29</b>		
6.1 Initial power on test .....	30		
6.2 Software updates .....	30		
6.3 Troubleshooting .....	31		
6.4 Sonar troubleshooting .....	32		
6.5 LED indications.....	33		
6.6 Resetting the sonar module .....	34		
<b>Chapter 7 Maintenance .....</b>	<b>35</b>		
7.1 Routine checks .....	36		
7.2 Unit cleaning instructions.....	36		
7.3 Transducer care and cleaning .....	37		
<b>Chapter 8 Technical support .....</b>	<b>39</b>		
8.1 Raymarine customer support .....	40		
8.2 Viewing product information.....	40		
<b>Chapter 9 Technical specification.....</b>	<b>41</b>		
9.1 Technical specification.....	42		
<b>Chapter 10 Options and accessories .....</b>	<b>43</b>		
10.1 Spares and accessories.....	44		
10.2 Network hardware .....	44		

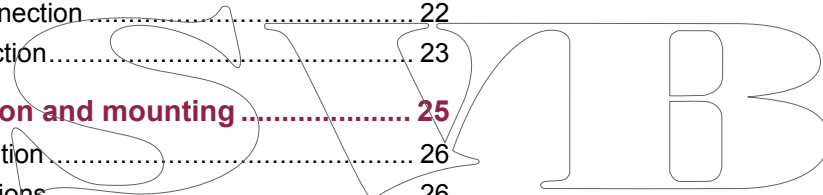

SWIB

# Chapter 1: Important information

## Safety notices



### Warning: Product installation and operation

This product must be installed and operated in accordance with the instructions provided. Failure to do so could result in personal injury, damage to your vessel and/or poor product performance.



### Warning: Potential ignition source

This product is NOT approved for use in hazardous/flammable atmospheres. Do NOT install in a hazardous/flammable atmosphere (such as in an engine room or near fuel tanks).



### Warning: High voltage

This product contains high voltage. Adjustments require specialized service procedures and tools only available to qualified service technicians. There are no user serviceable parts or adjustments. The operator should never remove the cover or attempt to service the product.



### Warning: Product grounding

Before applying power to this product, ensure it has been correctly grounded, in accordance with the instructions in this guide.



### Warning: Positive ground systems

Do not connect this unit to a system which has positive grounding.



### Warning: Switch off power supply

Ensure the vessel's power supply is switched OFF before starting to install this product. Do NOT connect or disconnect equipment with the power switched on, unless instructed in this document.



### Warning: Sonar operation

- NEVER operate the sonar with the vessel out of the water.
- NEVER touch the transducer face when the sonar is powered on.
- SWITCH OFF the sonar if divers are likely to be within 7.6 m (25 ft) of the transducer.



### Warning: Transducer cables

Do not remove the transducer cable whilst the product is powered on, doing so can cause sparks. If the transducer cable is accidentally removed whilst the product is powered on, switch the product's power off, replace the cable and then switch the power back on.

### Caution: Power supply protection

When installing this product ensure the power source is adequately protected by means of a suitably-rated fuse or automatic circuit breaker.

### Caution: Do not cut transducer cables

- Cutting the transducer cable severely reduces sonar performance. If the cable is cut, it must be replaced, it cannot be repaired.
- Cutting the transducer cable will void the warranty and invalidate the European CE mark.

### Caution: Service and maintenance

This product contains no user serviceable components. Please refer all maintenance and repair to authorized Raymarine dealers. Unauthorized repair may affect your warranty.

## General Information

### Water ingress

Water ingress disclaimer

Although the waterproof rating capacity of this product meets the IPX6 & IPX7 standard, water intrusion and subsequent equipment failure may occur if the product is subjected to commercial high-pressure washing. Raymarine will not warrant products subjected to high-pressure washing.

### EMC installation guidelines

Raymarine equipment and accessories conform to the appropriate Electromagnetic Compatibility (EMC) regulations, to minimize electromagnetic interference between equipment and minimize the effect such interference could have on the performance of your system

Correct installation is required to ensure that EMC performance is not compromised.

For optimum EMC performance we recommend that wherever possible:

- Raymarine equipment and cables connected to it are:
  - At least 1 m (3 ft) from any equipment transmitting or cables carrying radio signals e.g. VHF radios, cables and antennas. In the case of SSB radios, the distance should be increased to 7 ft (2 m).
  - More than 2 m (7 ft) from the path of a radar beam. A radar beam can normally be assumed to spread 20 degrees above and below the radiating element.
- The product is supplied from a separate battery from that used for engine start. This is important to prevent erratic behavior and data loss which can occur if the engine start does not have a separate battery.
- Raymarine specified cables are used.
- Cables are not cut or extended, unless doing so is detailed in the installation manual.

**Note: Where constraints on the installation prevent any of the above recommendations, always ensure the maximum possible separation between different items of electrical equipment, to provide the best conditions for EMC performance throughout the installation**

### Suppression ferrites

Raymarine cables may be fitted with suppression ferrites. These are important for correct EMC performance. If a ferrite has to be removed for any purpose (e.g. installation or maintenance), it must be replaced in the original position before the product is used.

Use only ferrites of the correct type, supplied by Raymarine authorized dealers.

## Connections to other equipment

Requirement for ferrites on non-Raymarine cables

If your Raymarine equipment is to be connected to other equipment using a cable not supplied by Raymarine, a suppression ferrite MUST always be attached to the cable near the Raymarine unit.

## Declaration of conformity

Raymarine UK Ltd. declares that this product is compliant with the essential requirements of EMC directive 2004/108/EC.

The original Declaration of Conformity certificate may be viewed on the relevant product page at [www.raymarine.com](http://www.raymarine.com).

## Product disposal

Dispose of this product in accordance with the WEEE Directive.



The Waste Electrical and Electronic Equipment (WEEE) Directive requires the recycling of waste electrical and electronic equipment. Whilst the WEEE Directive does not apply to some Raymarine products, we support its policy and ask you to be aware of how to dispose of this product.

## Warranty registration

To register your Raymarine product ownership, please visit [www.raymarine.com](http://www.raymarine.com) and register online.

It is important that you register your product to receive full warranty benefits. Your unit package includes a bar code label indicating the serial number of the unit. You will need this serial number when registering your product online. You should retain the label for future reference.

## IMO and SOLAS

The equipment described within this document is intended for use on leisure marine boats and workboats not covered by International Maritime Organization (IMO) and Safety of Life at Sea (SOLAS) Carriage Regulations.

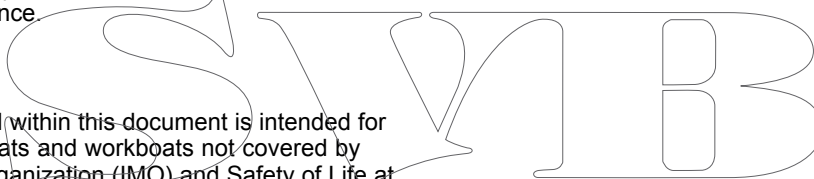

## Technical accuracy

To the best of our knowledge, the information in this document was correct at the time it was produced. However, Raymarine cannot accept liability for any inaccuracies or omissions it may contain. In addition, our policy of continuous product improvement may change specifications without notice. As a result, Raymarine cannot accept liability for any differences between the product and this document. Please check the Raymarine website ([www.raymarine.com](http://www.raymarine.com)) to ensure you have the most up-to-date version(s) of the documentation for your product.



## Chapter 2: Handbook and product information

### Chapter contents

- [2.1 Handbook information on page 10](#)
- [2.2 Product overview on page 10](#)
- [2.3 CHIRP Sonar overview on page 11](#)
- [2.4 CHIRP DownVision overview on page 11](#)

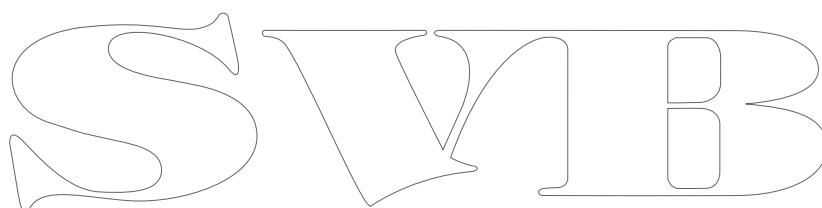
The image shows the letters 'SWIB' in a large, stylized, outlined font. The letters are white with a thin black outline. The 'S' is a simple, rounded shape. The 'W' is composed of two 'V' shapes joined at the top. The 'I' is a simple vertical bar. The 'B' is a simple, rounded shape with a vertical bar in the middle.

## 2.1 Handbook information

This handbook contains important information related to the installation of the CP100 sonar module.

The handbook includes information to help you:

- plan your installation and ensure you have all the necessary equipment;
- install and connect the CP100 as part of a wider system of connected marine electronics;
- troubleshoot problems and obtain technical support if required.

This and other Raymarine product documents are available to download in PDF format from [www.raymarine.com](http://www.raymarine.com).

## Related products

This document is applicable to the following product:

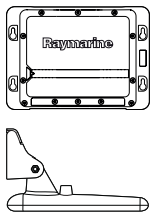
	Part number	Name	Description
	E70204	CP100	2-channel CHIRP / DownVision sonar module
	E70205	CP100 and CPT-100	2-channel CHIRP / DownVision sonar module and DownVision transom transducer.

## Product documentation

The following documentation is applicable to your product:

Description	Part number
<b>CP100 Installation instructions</b> Installation of a CP100 unit and connection to a wider system of marine electronics.	87194 / 88022
<b>CP100 Mounting template</b> Mounting diagram for surface mounting a CP100 unit.	87193
<b>CPT-100 Transom transducer Installation instructions</b> Installation of a DownVision transom-mount transducer.	87197 / 88024
<b>CPT-110 / CPT-120 Through-hull transducer Installation instructions</b> Installation of a DownVision through-hull transducer.	87201 / 88025
<b>New a Series, c Series, e Series Installation and operation instructions</b> Details the operation of the fishfinder application (including DownVision operation) for New a Series, c Series, e Series multifunction displays.	81337

## Further information

For detailed operating instructions, refer to the handbook that accompanies your multifunction display.

## Transducer installation instructions

This document includes installation instructions for the sonar module only. For installation instructions for a connected transducer, please refer to the documentation that accompanies the transducer.

## 2.2 Product overview

The CP100 is a CHIRP sonar module with DownVision capabilities. In conjunction with a compatible multifunction display, the CP100 provides a detailed view of the water's bottom structure, enabling you to identify fish and other objects in the water underneath your vessel.

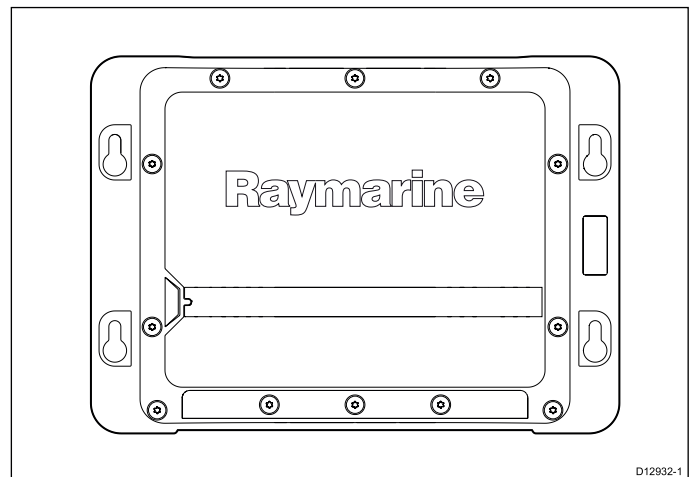

The CP100 has the following features:

- Dual-beam sonar (conical beam and fan beam).
- Typical depth performance of 600 ft.
- Water temperature sensing.
- Support for transom or through-hull DownVision transducers.
- Low power consumption.
- 12 V or 24 V operation.
- Waterproof to IPX 6 and IPX 7.
- Robust and waterproof high-speed network connection.

## 2.3 CHIRP Sonar overview

Sonar interprets signals from the transducer and builds up a detailed underwater view. The transducer sends pulses of sound waves into the water and measures the time it takes for the sound wave to travel to the bottom and back. The returning echoes are affected by bottom structure and by any other objects in their path, for example reefs, wrecks, shoals or fish.

Sonar produces a 25° conical shaped beam, the coverage of the conical beam is the water column directly beneath the vessel.

### Conical beam

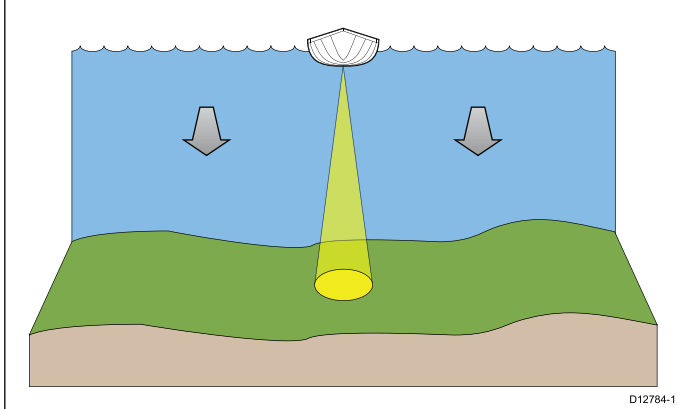

Sonar is effective at a range of speeds. In deeper waters the CHIRP bandwidth is automatically restricted to improve bottom lock and the detection of moving objects (e.g. fish) in the wider water column.

### CHIRP sonar screen example

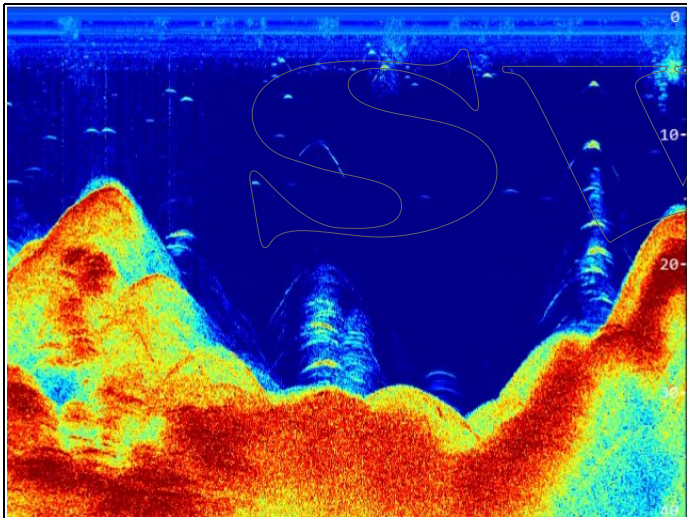

## 2.4 CHIRP DownVision overview

DownVision interprets signals from the transducer and builds up a detailed underwater view. The transducer sends pulses of sound waves into the water and measures the time it takes for the sound wave to travel to the bottom and back. The returning echoes are affected by bottom structure and by any other objects in their path, for example reefs, wrecks, shoals or fish.

DownVision produces a wide-angle side-to-side beam and a thin fore-to-aft beam. The coverage of the DownVision beam is a water column directly beneath and to the sides of the vessel.

### DownVision beam

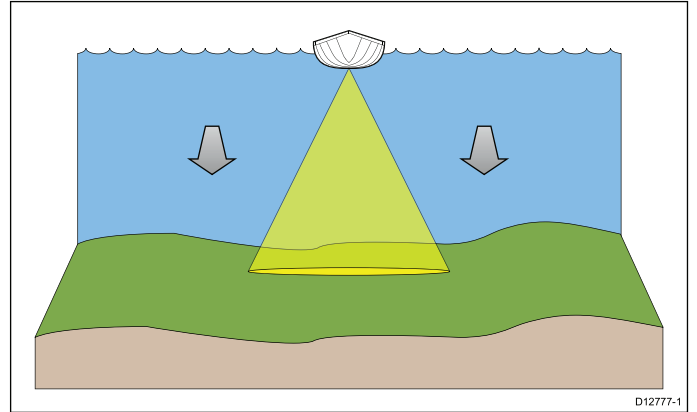

DownVision is effective at lower vessel speeds. In deeper waters the CHIRP bandwidth is automatically restricted to improve bottom lock and the detection of moving objects (e.g. fish) in the wider water column.

The wide, thin beam produces clear target returns. The use of CHIRP processing and a higher operating frequency provide a more detailed image, making it easier to identify bottom structures around which fish may reside.

### CHIRP DownVision screen example

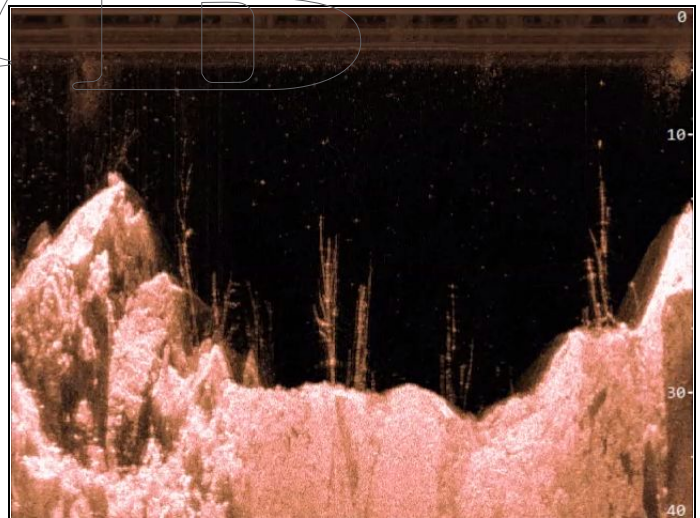

SWIB

# Chapter 3: Planning the installation

## Chapter contents

- [3.1 Installation checklist on page 14](#)
- [3.2 Parts supplied on page 14](#)
- [3.3 Required additional components on page 15](#)
- [3.4 Compatible multifunction displays on page 15](#)
- [3.5 Compatible transducers on page 16](#)
- [3.6 Typical systems on page 16](#)
- [3.7 Tools on page 17](#)

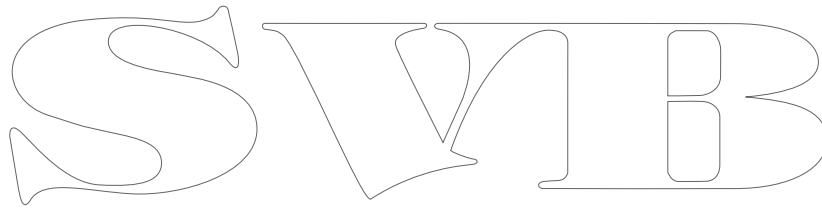

### 3.1 Installation checklist

Installation includes the following activities:

Installation Task	
1	Plan your system.
2	Obtain all required equipment and tools.
3	Site all equipment.
4	Route all cables.
5	Drill cable and mounting holes.
6	Make all connections into equipment.
7	Secure all equipment in place.
8	Power on and test the system.

### Schematic diagram

A schematic diagram is an essential part of planning any installation. It is also useful for any future additions or maintenance of the system. The diagram should include:

- Location of all components.
- Connectors, cable types, routes and lengths.

### 3.2 Parts supplied

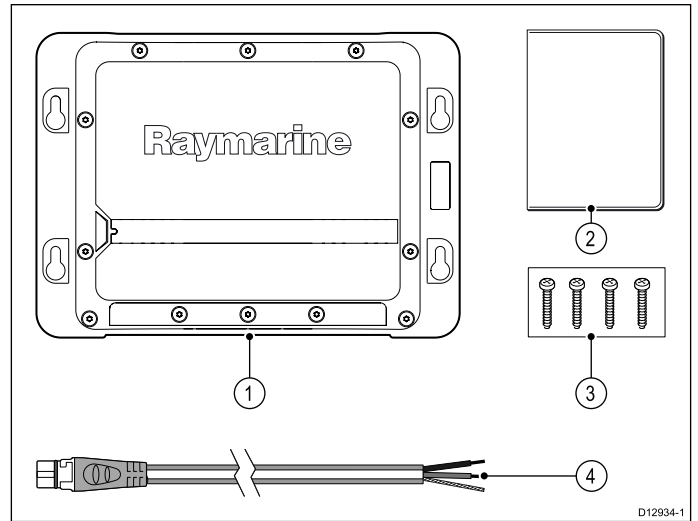

Item	Description	Quantity
1	Sonar module.	1
2	Documentation pack.	1
3	Screw.	4
4	Power cable 1 m (3.28 ft).	1

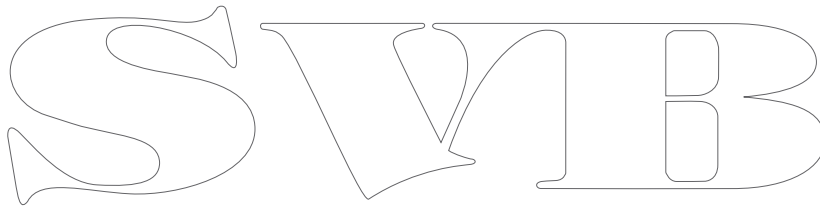

### 3.3 Required additional components

This product forms part of a system of electronics and requires the following additional components for full operation.

- Compatible DownVision transducer; transom or through-hull mount. Refer to [3.5 Compatible transducers](#) for a list of compatible products.
- Compatible Raymarine multifunction display. Refer to [3.4 Compatible multifunction displays](#) for a list of compatible products.
- Data cables. Refer to [Chapter 4 Cables and connections](#) for suitable cables. Some installations may also require extensions to data, power or transducer cables. Refer to the [Chapter 4 Cables and connections](#) and [Chapter 10 Options and accessories](#) sections for more information.

### 3.4 Compatible multifunction displays

This product is compatible with the following Raymarine multifunction displays.

- New a Series, New c Series, New e Series.
- gS Series.

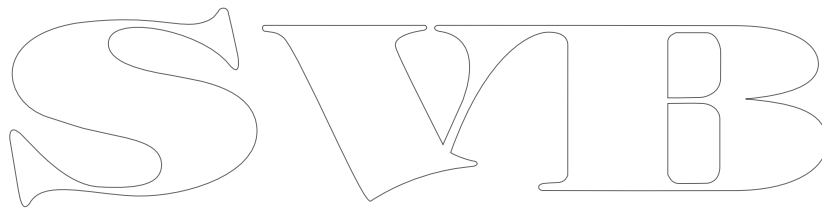

### 3.5 Compatible transducers

This product is compatible with the following Raymarine transducers.

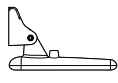
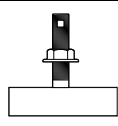
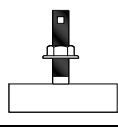
Part number	Description		Mounting Type	Construction
A80270	CPT-100 DownVision transducer		Transom	Plastic
A80277	CPT-110 DownVision transducer		Through-hull	Plastic
A80271	CPT-120 DownVision transducer		Through-hull	Bronze

### 3.6 Typical systems

Example: basic sonar system featuring multifunction display

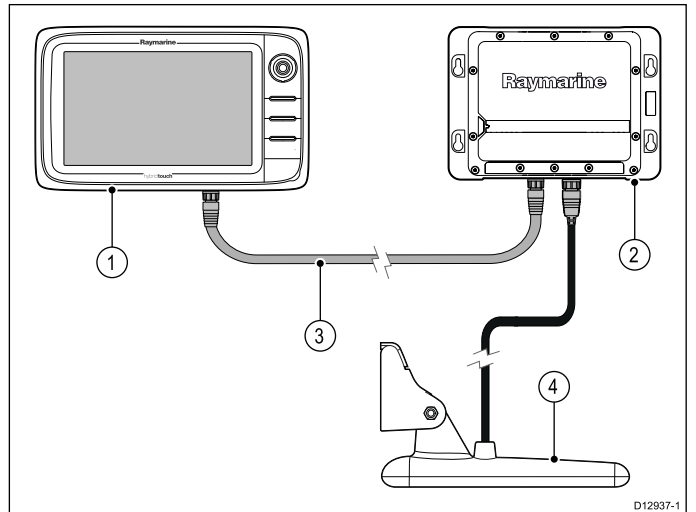

Item	Description	Part number
1	Multifunction display	Refer to your dealer for all compatible variants.
2	Sonar module	Refer to <a href="#">Related products</a> .
3	RayNet cable	Refer to <a href="#">10.4 Network cables</a> for RayNet cables.
4	DownVision transducer	Refer to <a href="#">3.5 Compatible transducers</a> .

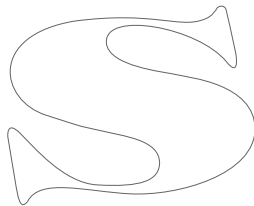

Example: expanded sonar system featuring autopilot system and multifunction display

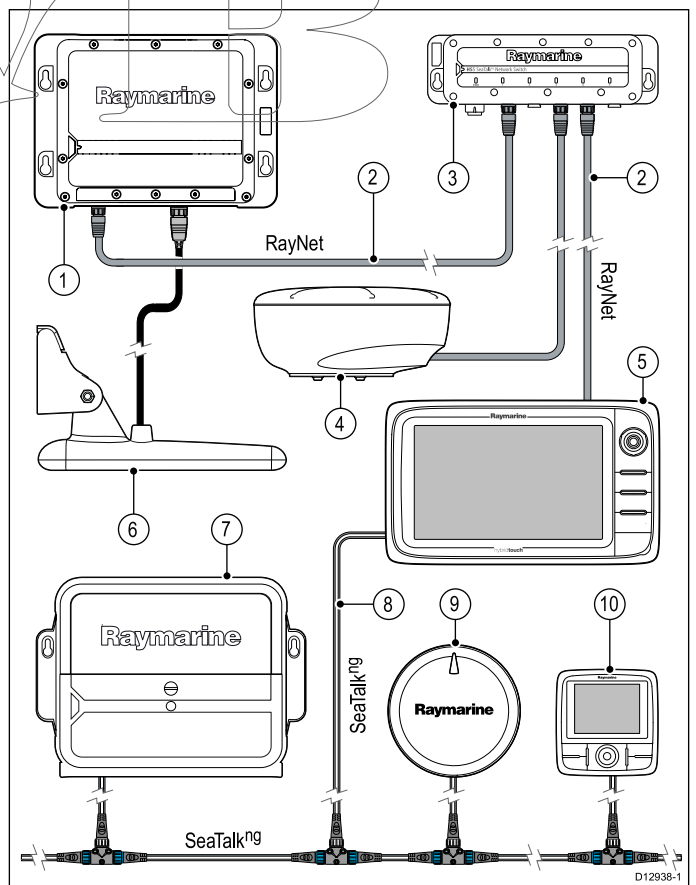



Item	Description	Part number
1	Sonar module	Refer to <a href="#">Related products</a> .
2	RayNet cables	Refer to <a href="#">10.4 Network cables</a> for RayNet cables.
3	RayNet network switch	A80007
4	Radar scanner	Refer to your dealer for all applicable part numbers.
5	Multifunction display	Refer to your dealer for all applicable part numbers.
6	DownVision transducer	Refer to <a href="#">3.5 Compatible transducers</a> .
7	Evolution ACU	Refer to your dealer for all applicable part numbers.
8	SeaTalk <sup>ng</sup> spur cable	Refer to <a href="#">10.5 SeaTalk<sup>ng</sup> cables and accessories</a> .
9	Evolution EV	Refer to your dealer for all applicable part numbers.
10	Pilot head controller	Refer to your dealer for all applicable part numbers.

### 3.7 Tools

Installation of the unit requires the following tools:

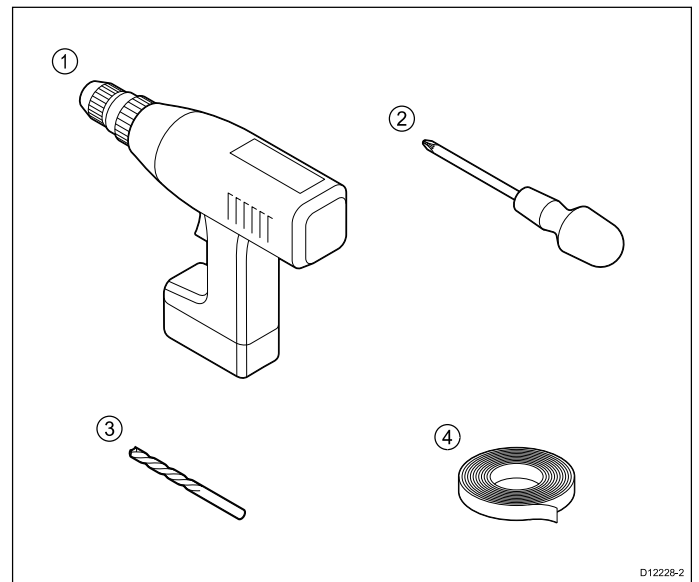

Item	Description
1	Drill
2	Pozidrive screwdriver
3	Drill bit of appropriate size*
4	Adhesive tape

**Note:** \*Drill bit size is dependent on the thickness and type of material that the unit is to be mounted on.

SVIB

SWIB

# Chapter 4: Cables and connections

## Chapter contents

- [4.1 General cabling guidance on page 20](#)
- [4.2 Connections overview on page 20](#)
- [4.3 Power connection on page 21](#)
- [4.4 Transducer connection on page 22](#)
- [4.5 Network connection on page 23](#)

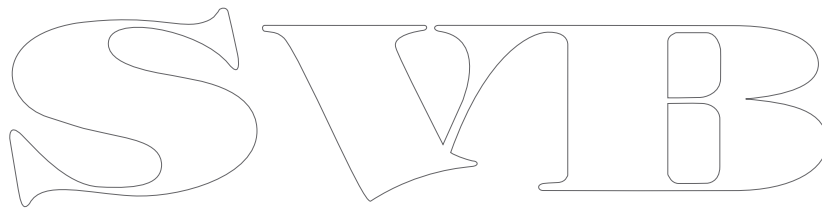

## 4.1 General cabling guidance

### Cable types and length

It is important to use cables of the appropriate type and length

- Unless otherwise stated use only standard cables of the correct type, supplied by Raymarine.
- Ensure that any non-Raymarine cables are of the correct quality and gauge. For example, longer power cable runs may require larger wire gauges to minimize voltage drop along the run.

### Routing cables

Cables must be routed correctly, to maximize performance and prolong cable life.

- Do NOT bend cables excessively. Wherever possible, ensure a minimum bend diameter of 200 mm (8 in) / minimum bend radius of 100 mm (4 in).

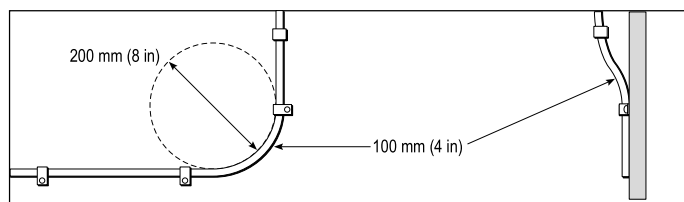

- Protect all cables from physical damage and exposure to heat. Use trunking or conduit where possible. Do NOT run cables through bilges or doorways, or close to moving or hot objects.
- Secure cables in place using tie-wraps or lacing twine. Coil any extra cable and tie it out of the way.
- Where a cable passes through an exposed bulkhead or deckhead, use a suitable watertight feed-through.
- Do NOT run cables near to engines or fluorescent lights.

Always route data cables as far away as possible from:

- other equipment and cables,
- high current carrying ac and dc power lines,
- antennae.

### Strain relief

Ensure adequate strain relief is provided. Protect connectors from strain and ensure they will not pull out under extreme sea conditions.

### Circuit isolation

Appropriate circuit isolation is required for installations using both AC and DC current:

- Always use isolating transformers or a separate power-inverter to run PC's, processors, displays and other sensitive electronic instruments or devices.
- Always use an isolating transformer with Weather FAX audio cables.
- Always use an isolated power supply when using a 3rd party audio amplifier.
- Always use an RS232/NMEA converter with optical isolation on the signal lines.
- Always make sure that PC's or other sensitive electronic devices have a dedicated power circuit.

### Cable shielding

Ensure that all data cables are properly shielded that the cable shielding is intact (e.g. hasn't been scraped off by being squeezed through a tight area).

## 4.2 Connections overview

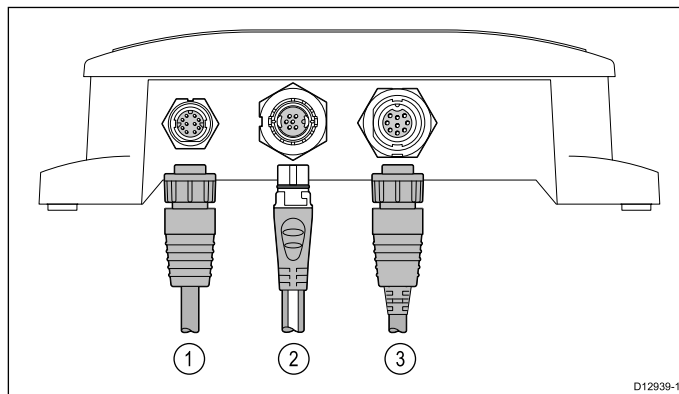

1. Network.
2. Power (12 V / 24 V dc).
3. Transducer.

### Making connections

Follow the steps below to connect network, transducer and power cables to your unit.

1. Ensure that the vessel's power supply is switched off.
2. Ensure that the device being connected to the unit has been installed in accordance with the installation instructions supplied with that device.
3. Ensuring correct orientation push the cable connector fully onto the corresponding connector on the unit.
4. Turn the locking collar clockwise to secure the cables.

### 4.3 Power connection

Always use the power cable provided with your product.

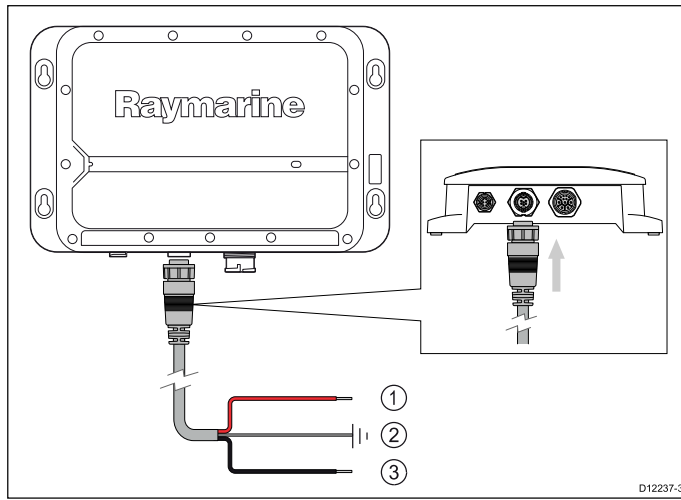

Item	Description
1	RED positive wire
2	Ground
3	BLACK negative wire

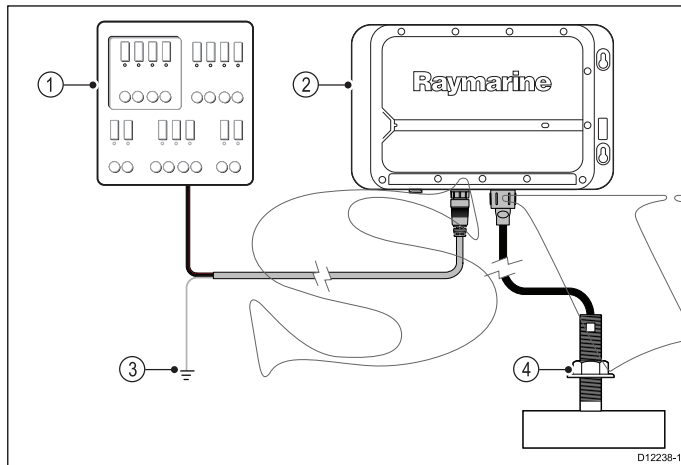

Item	Description
1	Power supply
2	Sonar module
3	Vessel's RF ground
4	Transducer

The unit is intended for use on dc 'negative' or 'floating' ground power systems rated from 10.2V to 32V.

Raymarine recommends that all power connections are made via a distribution panel. All equipment must be either:

- powered from a circuit breaker or switch, with 5A circuit protection, or
- powered from a 5A slow blow in-line fuse connected to the RED positive wire of the power cable.

The unit does not have a power switch. The unit is powered when the power cable is attached to the vessel's power supply.

**Note:** The unit should be mounted so that the power cable can be easily removed if necessary. If the unit is placed in a difficult to reach location, Raymarine recommends installing an on/off switch on the power connection at a point that is easily accessible.



**Warning: Do NOT connect a SeaTalk<sup>ng</sup> backbone to a 24 V power supply.**

To avoid possible damage to equipment, do NOT use the supplied power cable to connect a SeaTalk<sup>ng</sup> backbone to a 24 V power supply.



**Warning: Do NOT power this product from a SeaTalk<sup>ng</sup> backbone**

To avoid possible damage to equipment, do NOT use a SeaTalk<sup>ng</sup> backbone as the power source for this product.

#### Power cable extension

The product is supplied with a power cable, which can be extended if required.

- The power cable for each unit in your system should be run as a separate, single length of 2-wire cable from the unit to the vessel's battery or distribution panel.
- Raymarine recommends a **minimum** wire gauge of 18AWG (0.82 mm<sup>2</sup>) for any length of cable extension.
- Regardless of the length of the cable extension, any cable used should be capable of achieving a **minimum** voltage at the unit of 10.8 V with a fully flat battery at 11 V.

#### Breakers, fuses and circuit protection

It is recommended that you fit a thermal breaker or fuse at the distribution panel.

##### Thermal breaker rating

5 A (if only connecting one device)

**Note:** The suitable fuse rating for the thermal breaker is dependent on the number of devices you are connecting. If in doubt consult an authorized Raymarine dealer.

#### Sharing a breaker

Where more than 1 piece of equipment shares a breaker you must provide protection for the individual circuits. E.g. by connecting an in-line fuse for each power circuit.

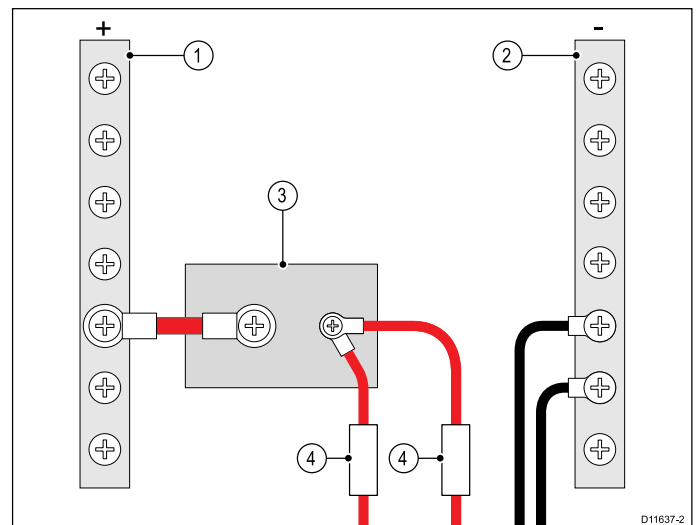

1	Positive (+) bar
2	Negative (-) bar
3	Circuit breaker
4	Fuse

Where possible, connect individual items of equipment to individual circuit breakers. Where this is not possible, use individual in-line fuses to provide the necessary protection.



### Warning: Product grounding

Before applying power to this product, ensure it has been correctly grounded, in accordance with the instructions in this guide.

### Grounding — Dedicated drain wire

The power cable supplied with this product includes a dedicated shield (drain) wire for connection to a vessel's RF ground point.

It is important that an effective RF ground is connected to the system. A single ground point should be used for all equipment. The unit can be grounded by connecting the shield (drain) wire of the power cable to the vessel's RF ground point. On vessels without an RF ground system the shield (drain) wire should be connected directly to the negative battery terminal.

The dc power system should be either:

- Negative grounded, with the negative battery terminal connected to the vessel's ground.
- Floating, with neither battery terminal connected to the vessel's ground



### Warning: Positive ground systems

Do not connect this unit to a system which has positive grounding.

## 4.4 Transducer connection

This product is designed for use with DownVision transducers.

- Refer to [3.5 Compatible transducers](#) for a list of compatible transducers.
- Transducers must be installed in accordance with the instructions provided with the transducer.

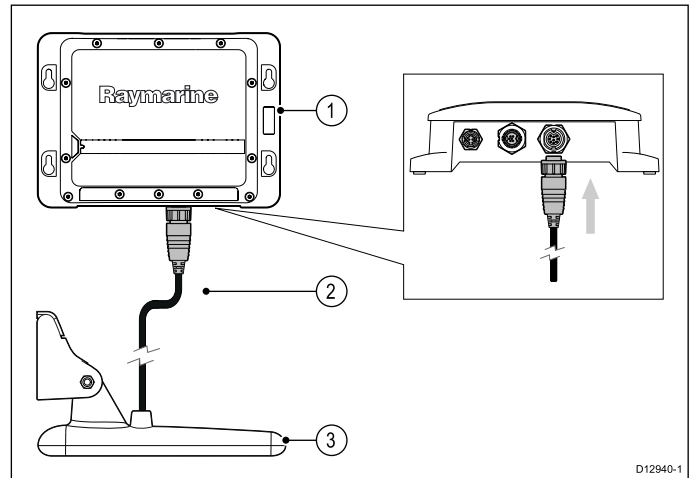

1. Sonar module.
2. Transducer cable (supplied with transducer).
3. DownVision transducer.



### Warning: Transducer cables

Do not remove the transducer cable whilst the product is powered on, doing so can cause sparks. If the transducer cable is accidentally removed whilst the product is powered on, switch the product's power off, replace the cable and then switch the power back on.

### Caution: Do not cut transducer cables

- Cutting the transducer cable severely reduces sonar performance. If the cable is cut, it must be replaced, it cannot be repaired.
- Cutting the transducer cable will void the warranty and invalidate the European CE mark.

### Transducer cable extension

For some installations it may be necessary to extend the transducer cable.

- Refer to [Chapter 10 Options and accessories](#) for a list of suitable transducer extension cables.
- Raymarine recommends a maximum of one cable extension for any single transducer cable.
- For best performance, keep all cable lengths to a minimum.

## 4.5 Network connection

The unit must be connected to a compatible Raymarine multifunction display to enable echo sounder data to be viewed.

### Multifunction display connection

Unit connected to a multifunction display using a RayNet cable.

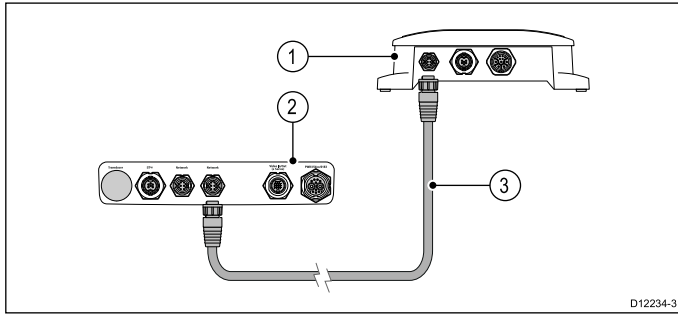

**Note:** The connection panel on your product may look slightly different to that shown, depending on variant. The network connection method remains the same for all products featuring RayNet connectors.

Item	Description
1	Sonar module.
2	Connector panel for compatible Raymarine multifunction display.
3	RayNet cable.

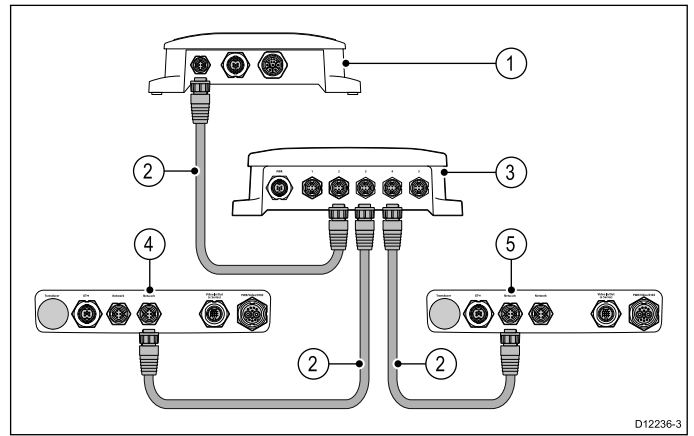

**Note:** The connection panel on your product may look slightly different to that shown, depending on variant. The network connection method remains the same for all products featuring RayNet connectors.

Item	Description
1	Sonar module.
2	RayNet cable.
3	RayNet network switch.
4	Connector panel for compatible Raymarine multifunction display.
5	Connector panel for additional compatible Raymarine multifunction display.

### Multifunction display configuration (extended cables)

When the required length of a single network cable run is greater than 20 m (65.6 ft), a RayNet (male) to (male) adaptor cable should be used to connect RayNet cables together.

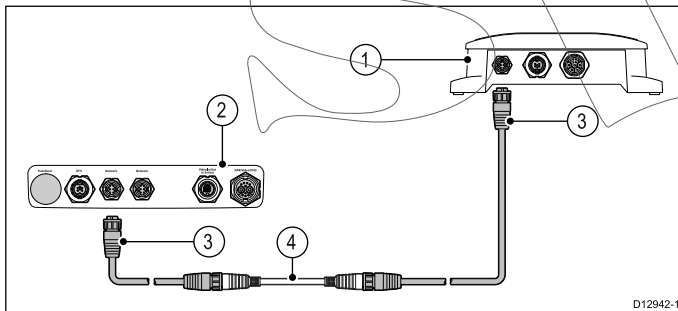

**Note:** The connection panel on your product may look slightly different to that shown, depending on variant. The network connection method remains the same for all products featuring RayNet connectors.

Item	Description
1	Sonar module.
2	Connector panel for compatible Raymarine multifunction display.
3	RayNet cables.
4	RayNet (Male) to (Male) adaptor cable.

### Multiple multifunction display configuration

A Raymarine network switch can be used to connect the unit to more than 1 multifunction display.

**Note:** Ensure network cables and connections are tight and secure using any cable ties provided with your network hardware.

For details on available network hardware and cables refer to [Chapter 10 Options and accessories](#).

SWIB



# Chapter 5: Location and mounting

## Chapter contents

- [5.1 Selecting a location on page 26](#)
- [5.2 Product dimensions on page 26](#)
- [5.3 Mounting on page 27](#)



## 5.1 Selecting a location



### Warning: Potential ignition source

This product is NOT approved for use in hazardous/flammable atmospheres. Do NOT install in a hazardous/flammable atmosphere (such as in an engine room or near fuel tanks).

### General location requirements

The unit should be mounted where it will be:

- protected from physical damage and excessive vibration.
- well ventilated and away from heat sources.
- away from any potential ignition source such as an engine room, near fuel tanks or a gas locker.

When choosing a location for the unit, consider the following points to ensure reliable and trouble-free operation:

- **Access** — there must be sufficient space to enable cable connections to the unit, avoiding tight bends in the cable.
- **Diagnostics** — the unit must be mounted in a location where the diagnostics LED is easily visible.
- **Interference** — the unit should be mounted far enough away from any equipment that may cause interference such as motors, generators and radio transmitters / receivers.
- **Magnetic compass** — mount the unit at least 1 m (3 ft.) away from a magnetic compass.
- **Power** — the unit must be located near a dc power source.

## 5.2 Product dimensions

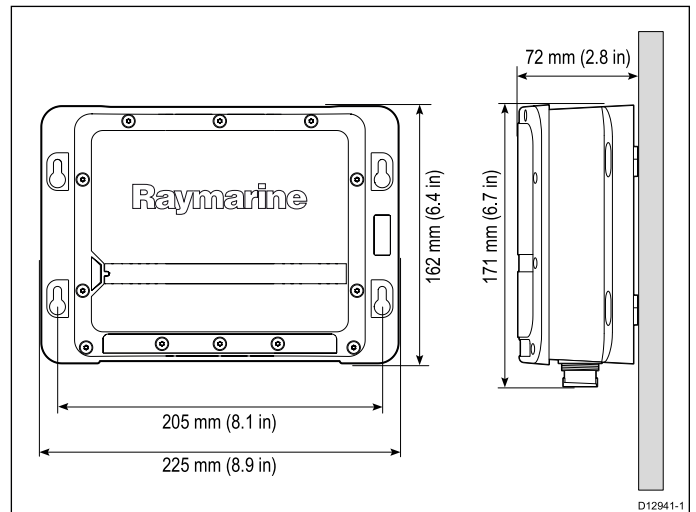

SVIB

## 5.3 Mounting

### Mounting the unit

Having chosen a suitable location, install the unit as follows:

**Note:** Raymarine recommends mounting the unit vertically.

1. Secure the mounting template in the required location using adhesive tape.

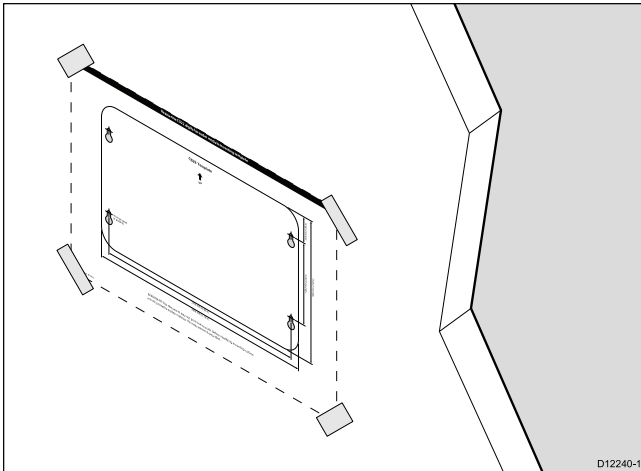

2. Drill 4 holes at the marked location on the template.

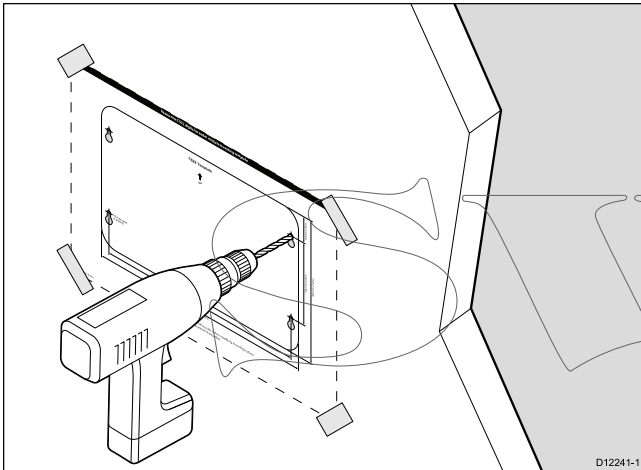

3. Remove the mounting template.
4. Screw in the supplied fixing screws about half way into the holes.
5. Place the unit onto the fixing screws.
6. Push the unit down to engage the key slots in the unit.
7. Tighten the screws

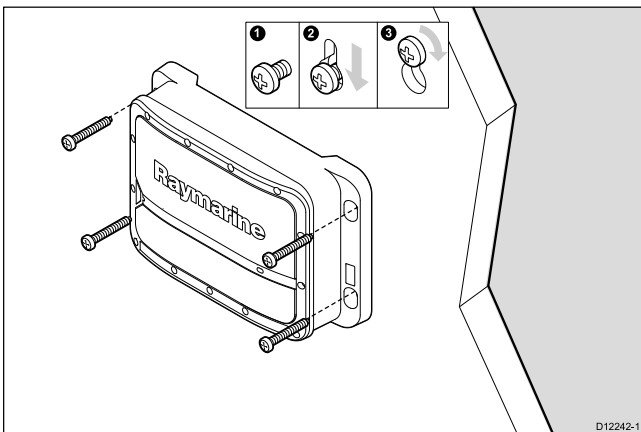

**Note:** Drill bit, tap size and tightening torque is dependent on the thickness and type of material the unit is to be mounted on.

SWIB

# Chapter 6: System checks and troubleshooting

## Chapter contents

- [6.1 Initial power on test on page 30](#)
- [6.2 Software updates on page 30](#)
- [6.3 Troubleshooting on page 31](#)
- [6.4 Sonar troubleshooting on page 32](#)
- [6.5 LED indications on page 33](#)
- [6.6 Resetting the sonar module on page 34](#)

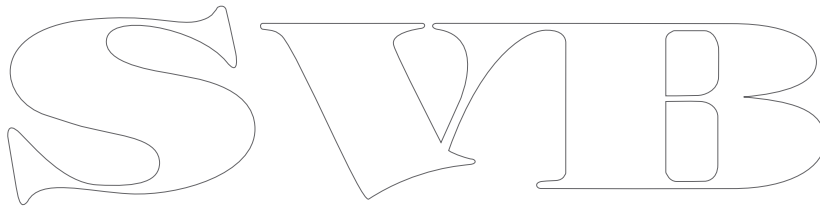

## 6.1 Initial power on test

Once the unit has been correctly installed check that it is operating correctly.

After powering on, the unit will take approximately 50 seconds to bootup, from powering on through to normal operation LED status indicator should be GREEN. If the LED status indicator is not green then refer to the troubleshooting section of this handbook.

Open the Fishfinder application on your connected multifunction display and ensure that it is operating correctly.

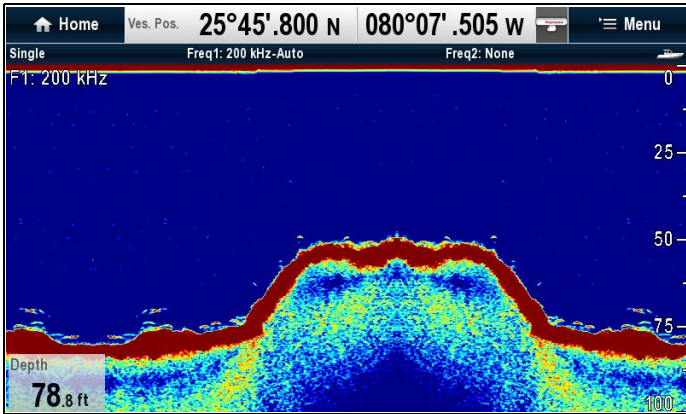

### Further information

For detailed operating instructions, refer to the handbook that accompanies your multifunction display.

### Multiple sonar operation

For systems with multiple sonar modules, only one sonar may operate at any one time.

Before attempting to use the fishfinder application on your multifunction display, use one of the methods described in this document to ensure that only one sonar module is active on your system.

#### Switching between internal and external sonar modules

If you want to switch your active sonar module between internal and external follow the steps below.

1. Power off the active sonar module.
  - Internal sonar module is turned off from the Fishfinder application menu: **Menu > Set-up > Sounder Set-up > Internal Sounder.**
  - External sonar modules should be turned off at the power supply.
2. Wait for the No Sounder Source Available message to be displayed in the Fishfinder application.
3. Power on the new sonar module.

#### Switching between multiple external sonar modules

If your system includes multiple external sonar modules you must complete the procedure detailed below to ensure only one sonar module is active at a time.

**Note:** If your multifunction display has an **internal** sonar module, complete the procedure detailed in [Switching between internal and external sonar modules](#) BEFORE attempting the following:

1. Power off ALL external sonar modules, either at the power supply or by disconnecting the power cable from the sonar module.
2. Wait for the No Sounder Source Available message to be displayed in the Fishfinder application.
3. Power on the external sonar module that you want to use.

## 6.2 Software updates

The software running on the product can be updated.

- Raymarine periodically releases software updates to improve product performance and add new features.
- You can update the software for your product using a connected and compatible multifunction display.
- Refer to [www.raymarine.com/software/](http://www.raymarine.com/software/) for the latest software updates and the software update procedure for your product.
- If in doubt as to the correct procedure for updating your product software, refer to your dealer or Raymarine technical support.

## 6.3 Troubleshooting

The troubleshooting information provides possible causes and corrective action required for common problems associated with marine electronics installations.

All Raymarine products are, prior to packing and shipping, subjected to comprehensive test and quality assurance programs. However, if you experience problems with the operation of your product this section will help you to diagnose and correct problems in order to restore normal operation.

If after referring to this section you are still having problems with your unit, please contact Raymarine Technical Support for further advice.

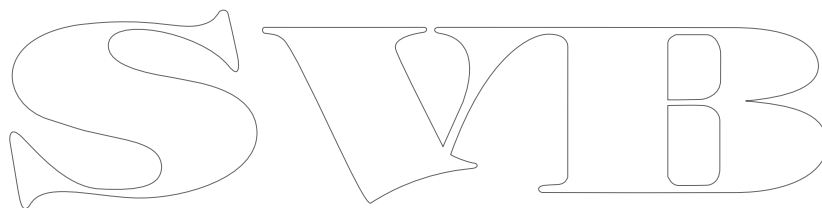
The image shows the letters 'SWIB' in a large, stylized, outlined font. The letters are white with a thin black outline. The 'S' is a simple, rounded shape. The 'W' is formed by two 'V' shapes joined at the top. The 'I' is a simple vertical bar. The 'B' is a simple, rounded shape with a vertical bar in the middle.

## 6.4 Sonar troubleshooting

Problems with the sonar and their possible causes and solutions are described here.



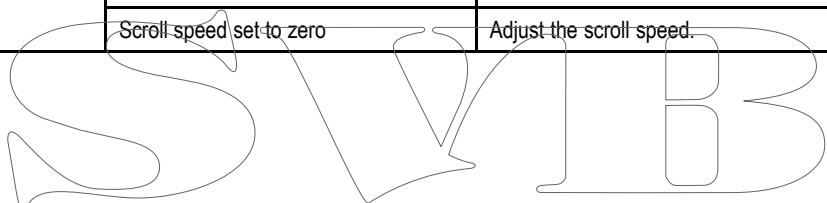







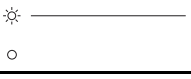





Problem	Possible causes	Possible solutions
Sonar data not available on multifunction display.	Unit power supply fault.	Check the unit power supply and cables.
	Other unit fault.	Refer to the instructions supplied with the unit.
	SeaTalk <sup>hs</sup> / RayNet network problem.	Check that the unit is correctly connected to a Raymarine network switch. If a crossover coupler or other coupler cable / adapter is used, check all connections (as applicable).
		Check the status of the Raymarine network switch (if applicable).
		Check that SeaTalk <sup>hs</sup> / RayNet cables are free from damage.
Software mismatch between equipment may prevent communication.	Contact Raymarine technical support.	
Problematic depth readings or sonar image.	Gain or Frequency settings may be inappropriate for present conditions.	Check the sonar presets, gain and frequency settings.
	Unit power supply fault.	Check the voltage from the power supply, if this is too low it can affect the transmitting power of the unit.
	Unit cable fault.	Ensure that the power, transducer and all other cables to the unit are properly connected and free from damage.
	Transducer fault.	Check that the transducer is mounted correctly and is clean.
		If you have a transom mount transducer, check that the transducer hasn't kicked-up due to hitting an object.
	Other unit fault.	Refer to the instructions supplied with the unit.
	Vessel stationary.	Fish arches are not displayed if the vessel is stationary; fish will appear on the display as straight lines.
	High vessel speed	Turbulence around the transducer may be confusing the unit.
Scroll speed set to zero	Adjust the scroll speed.	



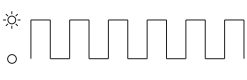

## 6.5 LED indications

The power LED for this product has a number of flashing (blinking) modes to provide status information for diagnostics and troubleshooting.

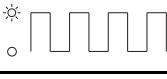
LED color	LED code	Status	User action	
		Solid Green	Power On	<ul style="list-style-type: none"> <li>None (normal power up takes &lt;1 minute.)</li> </ul>
		Green 1 blink	Normal operation	<ul style="list-style-type: none"> <li>None</li> </ul>
		Amber 1 blink	Transducer disconnected	<ul style="list-style-type: none"> <li>Ensure transducer cable and connections are secure and free from damage.</li> <li>Power cycle unit to recover transducer information.</li> <li>If problem persists contact Raymarine technical support.</li> </ul>
		Amber 2 blinks	No network detected	<ul style="list-style-type: none"> <li>Ensure network is powered.</li> <li>Ensure network cable and connections are secure and free from damage.</li> <li>If problem persists contact Raymarine technical support.</li> </ul>
		Amber 5 blinks	Under voltage (<10.2V)	<ul style="list-style-type: none"> <li>Ensure power cable and connections are secure and free from damage.</li> <li>Ensure power supply cabling is consistent with recommendations.</li> <li>If problem persists contact Raymarine technical support.</li> </ul>
		Amber 6 blinks	Over voltage (>34.2V)	<ul style="list-style-type: none"> <li>Ensure power supply levels are consistent with recommendations.</li> <li>If problem persists contact Raymarine technical support.</li> </ul>
		Red 1 blink	General failure	<ul style="list-style-type: none"> <li>If combined with voltage warning, check power supply and cables.</li> <li>Power-cycle the unit.</li> <li>If problem persists contact Raymarine technical support.</li> </ul>
		Red 3 blinks	Unit overheating	<ul style="list-style-type: none"> <li>Ensure installation environment is within recommendations.</li> <li>Unit will stop pinging and then start again once normal operating temperature is achieved.</li> <li>If problem persists contact Raymarine technical support.</li> </ul>
		Red 4 blinks	Problems with internal database	<ul style="list-style-type: none"> <li>Power-cycle the unit.</li> <li>If problem persists contact Raymarine technical support.</li> </ul>

**Note:** If any other LED sequence other than described above is seen and persists please contact Raymarine technical support.

## 6.6 Resetting the sonar module

You can use the reset function on a compatible Raymarine multifunction display to restore the sonar module to its factory default settings.

In the fishfinder application:

1. Select **Menu**.
2. Select **Set-up**.
3. Select **Sounder Set-up**.
4. Select **Sonar Reset**.
5. Select **Yes** to confirm or **No** to abort the operation, as appropriate.

The unit will now be reset to factory default settings.

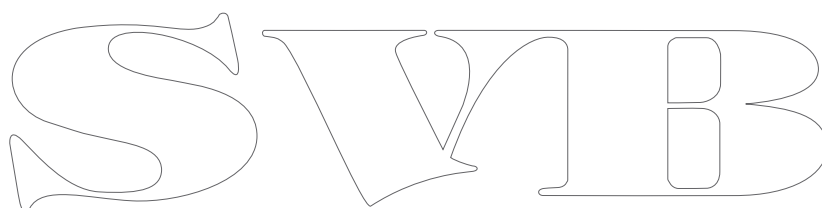
A large, stylized outline logo consisting of the letters 'S', 'W', 'I', and 'B' in a decorative, serif font. The letters are connected and have a classic, elegant appearance.

# Chapter 7: Maintenance

## Chapter contents

- [7.1 Routine checks on page 36](#)
- [7.2 Unit cleaning instructions on page 36](#)
- [7.3 Transducer care and cleaning on page 37](#)

SVIB

## 7.1 Routine checks

This product is a sealed unit. Maintenance procedures are therefore limited to the following periodic checks:

- Examine cables for signs of damage, such as chafing, cuts or nicks.
- Check that the cable connectors are firmly attached

**Note:** Cables checks should be carried out with the power supply switched off.



### **Warning: High voltage**

This product contains high voltage. Adjustments require specialized service procedures and tools only available to qualified service technicians. There are no user serviceable parts or adjustments. The operator should never remove the cover or attempt to service the product.

## 7.2 Unit cleaning instructions

The unit does not require regular cleaning. However, if you find it necessary to clean the unit, please follow the steps below:

1. Ensure power is switched off.
2. Wipe unit clean with a damp cloth.
3. If necessary, use a mild detergent solution to remove grease marks.

SWIB

## 7.3 Transducer care and cleaning

Growth can collect on the bottom of the transducer, this can reduce performance. To prevent the build-up of sea growth, coat the transducer with a thin layer of water-based antifouling paint, available from your local marine dealer. Reapply paint every 6 months or at the beginning of each boating season. Certain smart transducers have restrictions on where antifouling paint is applied. Please consult your dealer.

**Note:** Transducers with a temperature sensor may not work properly if painted.

**Note:** Never use ketone-based paint. Ketones can attack many plastics, possibly damaging the sensor.

**Note:** Never use spray paint on your transducer. Spraying incorporates tiny air bubbles, and a marine transducer cannot transmit properly through air.

Use a soft cloth and mild household detergent to clean the transducer. If the fouling is severe, remove the growth with a tough cleaning pad, such as a green Scotch Brite™ pad for example. Be careful to avoid scratching the face of the transducer.

**Note:** Harsh cleaning solvents such as acetone may damage the transducer.

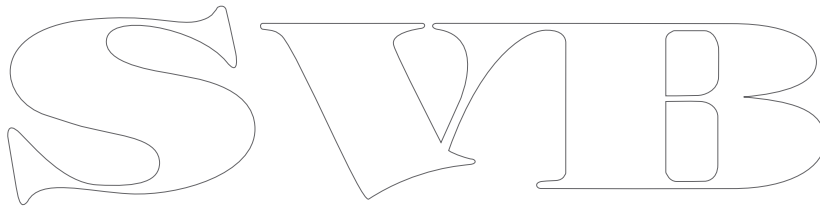
The image shows the word "SCOTCH BRITE" in a large, stylized, outlined font. The letters are white with a black outline, and the font is a classic serif typeface. The letters are spaced out and centered horizontally.

SWIB

# Chapter 8: Technical support

## Chapter contents

- [8.1 Raymarine customer support on page 40](#)
- [8.2 Viewing product information on page 40](#)

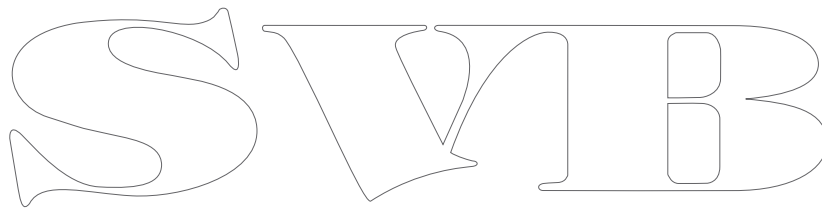

## 8.1 Raymarine customer support

Raymarine provides a comprehensive customer support service. You can contact customer support through the Raymarine website, telephone and e-mail. If you are unable to resolve a problem, please use any of these facilities to obtain additional help.

### Web support

Please visit the customer support area of our website at:

[www.raymarine.com](http://www.raymarine.com)

This contains Frequently Asked Questions, servicing information, e-mail access to the Raymarine Technical Support Department and details of worldwide Raymarine agents.

### Telephone and e-mail support

#### In the USA:

- **Tel:** +1 603 324 7900
- **Toll Free:** +1 800 539 5539
- **E-mail:** [support@raymarine.com](mailto:support@raymarine.com)

#### In the UK, Europe, and the Middle East:

- **Tel:** +44 (0)13 2924 6777
- **E-mail:** [ukproduct.support@raymarine.com](mailto:ukproduct.support@raymarine.com)

#### In Southeast Asia and Australia:

- **Tel:** +61 (0)29479 4800
- **E-mail:** [aus.support@raymarine.com](mailto:aus.support@raymarine.com)

### Product information

If you need to request service, please have the following information to hand:

- Product name.
- Product identity.
- Serial number.
- Software application version.
- System diagrams.

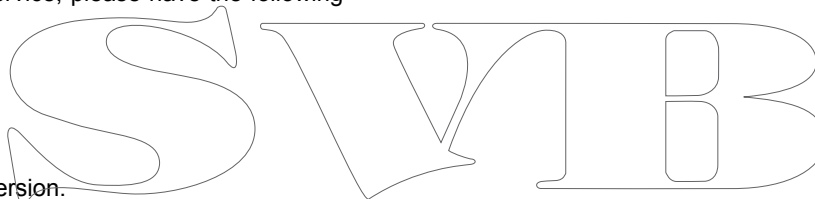

You can obtain this product information using the menus within your product.

## 8.2 Viewing product information

You can view information about your unit from the **Diagnostics** menu on a compatible multifunction display. This option displays information such as product serial number and software version.

With the Homescreen displayed:

1. Select **Set-up**.
2. Select **Maintenance**.
3. Select **Diagnostics**.
4. Select the **Select Device** option.  
A list of connected devices is displayed.
5. Select the product for which you want to view information. Alternatively, select **Show All Data** to display information for all connected products.



# Chapter 9: Technical specification

## Chapter contents

- [9.1 Technical specification on page 42](#)

SWIB

## 9.1 Technical specification

### Physical specification

Dimensions	<ul style="list-style-type: none"> <li>• <b>Width:</b> 225 mm (8.9 in).</li> <li>• <b>Height:</b> 162 mm (6.4 in).</li> <li>• <b>Height (including connectors):</b> 171 mm (6.7 in).</li> <li>• <b>Depth:</b> 72 mm (2.8 in).</li> </ul>
Weight	0.6 kg (1.32 lbs)

### Power specification

Nominal supply voltage	12 V / 24 V dc
Operating voltage range	10.8 V to 31.2 V dc
Power consumption	5.6 W (maximum)
Current	1 A peak
Fuse / breakers	5 A

### Sonar / DownVision specification

Channels	2 x CHIRP (1 x sonar and 1 x DownVision)
Operating frequencies	<ul style="list-style-type: none"> <li>• <b>Sonar</b> — Centered 200 KHz</li> <li>• <b>DownVision</b> — Centered 350 KHz</li> </ul>
Beam coverage	<ul style="list-style-type: none"> <li>• <b>Sonar</b> — 25° conical beam.</li> <li>• <b>DownVision</b> — Wide (port / starboard) and thin (fore / aft) fan beam.</li> </ul>
Target separation	Achieved through CHIRP processing: <ul style="list-style-type: none"> <li>• <b>Sonar</b> — 32 mm (1.25 in).</li> <li>• <b>DownVision</b> — 25 mm (1 in).</li> </ul>
Depth	Typical depth performance of 189 m (600 ft). Applies to both Sonar and DownVision channels.

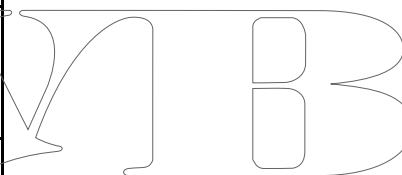

### Environmental specification

Operating temperature	0°C to +55°C (+32°F to +131°F)
Storage temperature	-30°C to +70°C (-22°F to +158°F)
Relative humidity	95%
Waterproof rating	IPX6 and IPX7

### Conformance specification

Conformance	<ul style="list-style-type: none"> <li>• EN 60945:2002</li> <li>• EMC Directive 2004/108/EC</li> <li>• Australia and New Zealand: C-Tick, Compliance Level 2</li> </ul>
-------------	---

# Chapter 10: Options and accessories

## Chapter contents

- [10.1 Spares and accessories on page 44](#)
- [10.2 Network hardware on page 44](#)
- [10.3 Network cable connector types on page 45](#)
- [10.4 Network cables on page 45](#)
- [10.5 SeaTalk<sup>ng</sup> cables and accessories on page 46](#)

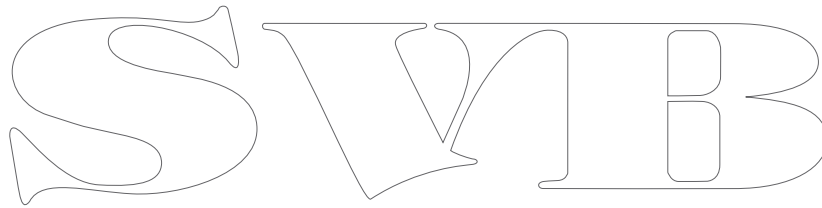

## 10.1 Spares and accessories

The following accessories and spare parts are available for the CP100:

### Spares

Item	Part number
1 m (3.28 ft) power cable	A06049

### Accessories

Item	Part number
4 m (13.12 ft) transducer extension cable for CPT-100 transom transducer	A80273
CPT-100 Transom DownVision transducer	A80270
CPT-110 Through-hull DownVision transducer (plastic)	A80277
CPT-120 Through-hull DownVision transducer (bronze)	A80271
Transom transducer shield for vessels with a trolling motor	A80207

## 10.2 Network hardware

Item	Part number	Notes
HS5 RayNet network switch	A80007	5-port switch for network connection of multiple devices featuring RayNet connectors. Equipment with RJ45 SeaTalk <sup>hs</sup> connectors can also be connected via suitable adapter cables.
RJ45 SeaTalk <sup>hs</sup> network switch	E55058	8-port switch for network connection of multiple SeaTalk <sup>hs</sup> devices featuring RJ45 connectors.
RJ45 SeaTalk <sup>hs</sup> crossover coupler	E55060	Enables direct connection of RJ45 SeaTalk <sup>hs</sup> devices to smaller systems where a switch is not required. Also enables the connection of RJ45 SeaTalk <sup>hs</sup> devices to an HS5 RayNet network switch (in conjunction with suitable adapter cables).
Ethernet RJ45 coupler	R32142	Enables direct connection of compatible thermal cameras to smaller systems where a network switch is not required. Also enables connection to larger systems via an RJ45 SeaTalk <sup>hs</sup> network switch or HS5 RayNet network switch (in conjunction with suitable adapter cables).

S V I B

## 10.3 Network cable connector types

There are 2 types of network cable connector — RayNet, and RJ45 SeaTalk<sup>hs</sup>.

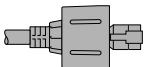
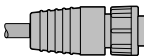
	<b>RJ45 SeaTalk<sup>hs</sup> connector.</b>
	<b>RayNet connector.</b>

## 10.4 Network cables

### RayNet to RayNet cables

Cable	Part number
400 mm (1.3 ft) RayNet to RayNet cable (female)	A80161
2 m (6.56 ft) RayNet to RayNet cable (female)	A62361
5 m (16.4 ft) RayNet to RayNet cable (female)	A80005
10 m (32.8 ft) RayNet to RayNet cable (female)	A62362
20 m (65.6 ft) RayNet to RayNet cable (female)	A80006
50 mm (1.97 in) RayNet to RayNet cable (male)	A80162
RayNet right-angled coupler	A80262
RayNet cable puller 5-pack	R70014

### RayNet to RJ45 SeaTalk<sup>hs</sup> adapter cables

Cable	Part number
1 m (3.28 ft) RayNet to RJ45 SeaTalk <sup>hs</sup> cable	A62360
3 m (9.84 ft) RayNet to RJ45 SeaTalk <sup>hs</sup> cable	A80151
10 m (32.8 ft) RayNet to RJ45 SeaTalk <sup>hs</sup> cable	A80159
400 mm (1.3 ft) RayNet to RJ45 SeaTalk <sup>hs</sup> (female) cable	A80160

SVIB

## 10.5 SeaTalk<sup>ng</sup> cables and accessories

SeaTalk<sup>ng</sup> cables and accessories for use with compatible products.

Description	Part No	Notes
SeaTalk <sup>ng</sup> starter kit	T70134	Includes: <ul style="list-style-type: none"> <li>• 1 x 5 Way connector (A06064)</li> <li>• 2 x Backbone terminator (A06031)</li> <li>• 1 x 3 m (9.8 ft) spur cable (A06040)</li> <li>• 1 x Power cable (A06049)</li> </ul>
SeaTalk <sup>ng</sup> Backbone Kit	A25062	Includes: <ul style="list-style-type: none"> <li>• 2 x 5 m (16.4 ft) Backbone cable (A06036)</li> <li>• 1 x 20 m (65.6 ft) Backbone cable (A06037)</li> <li>• 4 x T-piece (A06028)</li> <li>• 2 x Backbone terminator (A06031)</li> <li>• 1 x Power cable (A06049)</li> </ul>
SeaTalk <sup>ng</sup> 0.4 m (1.3 ft) spur	A06038	
SeaTalk <sup>ng</sup> 1 m (3.3 ft) spur	A06039	
SeaTalk <sup>ng</sup> 3 m (9.8 ft) spur	A06040	
SeaTalk <sup>ng</sup> 5 m (16.4 ft) spur	A06041	
SeaTalk <sup>ng</sup> 0.4 m (1.3 ft) elbow spur	A06042	
SeaTalk <sup>ng</sup> 0.4 m (1.3 ft) backbone	A06033	
SeaTalk <sup>ng</sup> 1 m (3.3 ft) backbone	A06034	
SeaTalk <sup>ng</sup> 3 m (9.8 ft) backbone	A06035	
SeaTalk <sup>ng</sup> 5 m (16.4 ft) backbone	A06036	
SeaTalk <sup>ng</sup> 9 m (29.5 ft) backbone	A06068	
SeaTalk <sup>ng</sup> 20 m (65.6 ft) backbone	A06037	
SeaTalk <sup>ng</sup> to bare ends 1 m (3.3 ft) spur	A06043	
SeaTalk <sup>ng</sup> to bare ends 3 m (9.8 ft) spur	A06044	
SeaTalk <sup>ng</sup> Power cable	A06049	
SeaTalk <sup>ng</sup> Terminator	A06031	
SeaTalk <sup>ng</sup> T-piece	A06028	Provides 1 x spur connection
SeaTalk <sup>ng</sup> 5-way connector	A06064	Provides 3 x spur connections
SeaTalk <sup>ng</sup> backbone extender	A06030	
SeaTalk to SeaTalk <sup>ng</sup> converter kit	E22158	Allows the connection of SeaTalk devices to a SeaTalk <sup>ng</sup> system.

Description	Part No	Notes
SeaTalk <sup>ng</sup> Inline terminator	A80001	Provides direct connection of a spur cable to the end of a backbone cable. No T-piece required.
SeaTalk <sup>ng</sup> Blanking plug	A06032	
ACU / SPX SeaTalk <sup>ng</sup> spur cable 0.3 m (1.0 ft)	R12112	Connects an SPX course computer or an ACU to a SeaTalk <sup>ng</sup> backbone.
SeaTalk (3 pin) to SeaTalk <sup>ng</sup> adaptor cable 0.4 m (1.3 ft)	A06047	
SeaTalk to SeaTalk <sup>ng</sup> spur 1 m (3.3 ft) spur	A22164	
SeaTalk2 (5 pin) to SeaTalk <sup>ng</sup> adaptor cable 0.4 m (1.3 ft)	A06048	
DeviceNet adaptor cable (Female)	A06045	Allows the connection of NMEA 2000 devices to a SeaTalk <sup>ng</sup> system.
DeviceNet adaptor cable (Male)	A06046	Allows the connection of NMEA 2000 devices to a SeaTalk <sup>ng</sup> system.
DeviceNet adaptor cable (Female) to bare ends.	E05026	Allows the connection of NMEA 2000 devices to a SeaTalk <sup>ng</sup> system.
DeviceNet adaptor cable (Male) to bare ends.	E05027	Allows the connection of NMEA 2000 devices to a SeaTalk <sup>ng</sup> system.

SWIB

**Raymarine**<sup>®</sup>  
A FLIR COMPANY  
SVIB