



**STANDARD HORIZON**

**VLH-3000**

**30 Watt Loud Hailer**

---

## **Owner's Manual**

- Four Fog Horns, Bells and Whistles
- New Connetic Design for a Consistent Look with other Standard Horizon Products
- Flush Mount Capability
- Two 30 Watt PA Outputs, One Forward One After
- Two Intercom Connections Allow You to Toggle Between IC 1 and IC2
- Microphone Features Dedicated Button for Access to Intercom Stations
- External Speaker Output: 4 W Max. at 4 ohm



## TABLE OF CONTENTS

<b>1</b>	<b>GENERAL INFORMATION</b> .....	<b>3</b>
<b>2</b>	<b>PACKING LIST</b> .....	<b>4</b>
<b>3</b>	<b>OPTION</b> .....	<b>4</b>
<b>4</b>	<b>INSTALLATION</b> .....	<b>5</b>
	4.1 Optional MMB-84 Flush Mount Installtion .....	5
	4.2 Electrical Installation .....	6
<b>5</b>	<b>CONTROLS AND SWITCHES</b> .....	<b>8</b>
<b>6</b>	<b>OPERATION</b> .....	<b>10</b>
	6.1 Switching Power On/Off .....	10
	6.2 Hail/Listen Back .....	10
	6.3 Intercom .....	11
	6.4 Automatic Signaling .....	12
<b>7</b>	<b>FOG ALERT TONE FREQUENCY</b> .....	<b>14</b>
<b>8</b>	<b>MAINTENANCE</b> .....	<b>16</b>
	8.1 Replacement Parts .....	16
	8.2 Factory Service .....	17
	8.3 Troubleshooting Chart .....	17
<b>9</b>	<b>WARRANTY</b> .....	<b>18</b>
<b>10</b>	<b>SPECIFICATIONS</b> .....	<b>22</b>

## 1 GENERAL INFORMATION

The STANDARD HORIZON **VLH-3000** is a marine Loud Hailer that operates as a multifunction unit. It has three modes:

- Hail/Listen-Back
- Intercom
- Automatic Signalling

In the **Hail/Listen-Back** mode, the Loud Hailer can send amplified audio signals to a PA horn and then listen back for signals coming in from the PA horn.

In the **Intercom** mode, the Loud Hailer can have private conversations with up to two **MLS-300i** intercom stations.

In the **Automatic Signaling** mode, the Loud Hailer can send different kinds of signals used mostly to alert nearby vessels to the presence and approximate position, and to indicate the vessel's status or maneuverability limitation.

Your Loud Hailer requires 13.8 VDC ( $\pm 20\%$ ) power input. The **VLH-3000** maximum PA speaker output is 30W.

### ON-LINE WARRANTY REGISTRATION

Please visit [www.standardhorizon.com](http://www.standardhorizon.com) to register the **VLH-3000** Loud Hailer. It should be noted that visiting the Web site from time to time may be beneficial to you, as new products are released they will appear on the STANDARD HORIZON Web site.

### PRODUCT SUPPORT INQUIRIES

If you have any questions or comments regarding the use of the **VLH-3000**, you can visit the STANDARD HORIZON Web site to send an E-Mail or contact the Product Support team at 800-767-2450 M-F 7:00-5:00PST.

## 2 PACKING LIST

When the package containing the Loud Hailer is first opened, please check it for the following contents:

- **VLH-3000** Loud Hailer (with Microphone)
- Mounting Bracket (with attaching hardware and hanger kit)
- Owner's Manual
- Power Cord
- Dust Cover

## 3 OPTIONS

<b>MMB-84</b> .....	Flush-Mount Bracket
<b>MLS-300i</b> .....	Intercom Speaker
<b>MLS-300</b> .....	External Loudspeaker
<b>MLS-310</b> .....	Amplified External Speaker
<b>101W</b> .....	White External Speaker
<b>220SW</b> .....	4.5" Round Hail/PA Horn
<b>240SW</b> .....	5" x 8" Rectangular Hail/PA Horn

## 4 INSTALLATION

### 4.1 Optional MMB-84 Flush Mount Installation

1. To assist in flush mounting, a template has been included. Use this template to find the mounting location.
2. Use the template to mark the location where the rectangular hole is to be cut. Confirm the space behind the dash or panel is deep enough to accommodate the **VLH-3000** (at least 4.5 inches or 11.5 cm deep). There should be at least 1/2 inch (1.3 cm) between the **VLH-3000's** heatsink and any wiring, cables or structures.
3. Cut out the rectangular hole and insert the **VLH-3000**.
4. Fasten the brackets to the sides of the **VLH-3000** with the lock washer nut combination; so that the mounting screw base faces the mounting surface (see Figure 1).
5. Turn the adjusting screw to adjust the tension so that the **VLH-3000** is tight against the mounting surface.

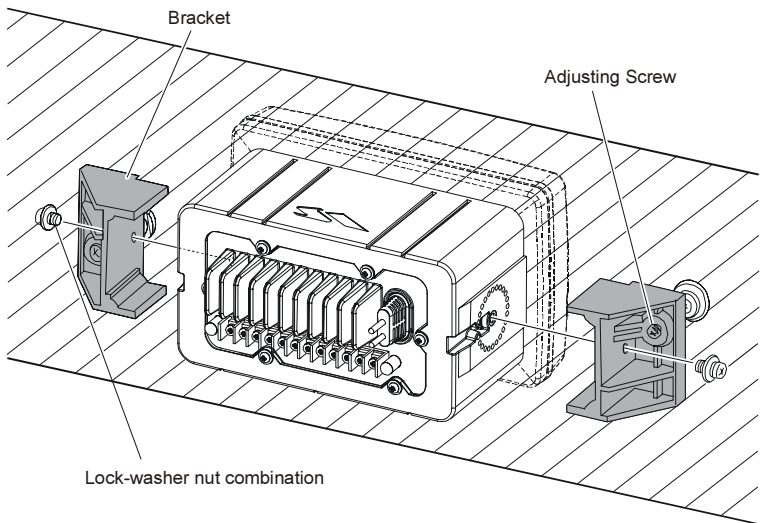

Figure 1. MMB-84 Flush Mount Installation

## 4.2 Electrical Installation

The rear panel of the **VLH-3000** contains:

- A DC Power Cord
- A terminal strip for the External Speaker, two PA Horns, and two **MLS-300i** Intercom Speakers.

Refer to Figure 2 and complete the following steps for the electrical installation.

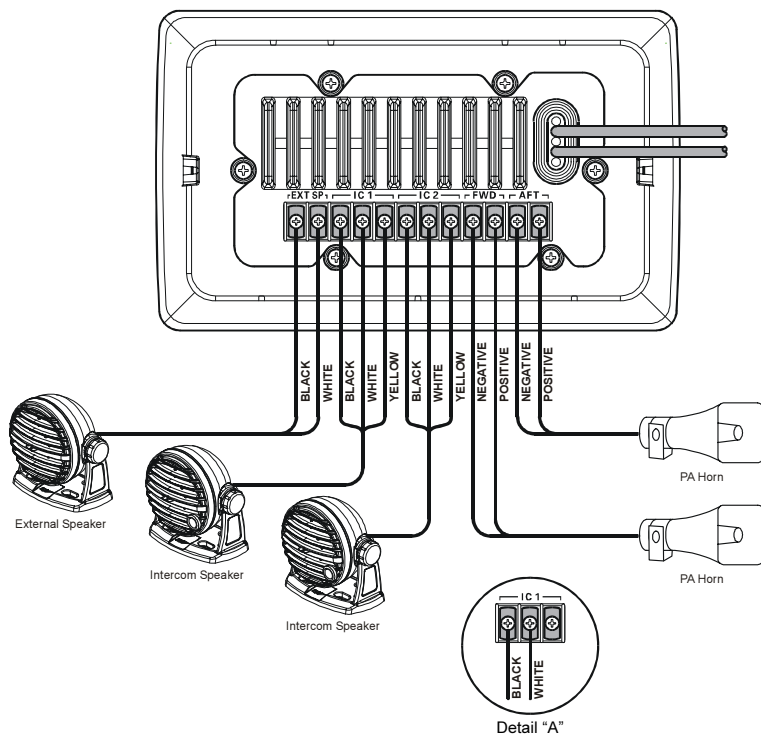

Figure 2. Electrical Connections

### NOTE

The terminal strip is not waterproof. Care needs to be taken when installing so it is not directly exposed to the elements.

1. Use the supplied Power Cord assembly for power connection. Connect the red wire to the “Positive (+)” terminal, and the black wire to the “Negative (-)” terminal of the power source.

### CAUTION





**Reverse polarity connections will damage the VLH-3000**

2. Use #22 AWG (or larger) stranded, plastic-jacketed wire to connect the PA Horns (“FWD” and “AFT” terminals) and Intercom Speakers (“IC1” and “IC2” terminals).
3. An external 4-Ohm 6 W speaker may be connected (“EXT SP” terminal), if desired.
4. For the PA Horn, it is recommended that a 4-Ohm 30 W horn speaker be used. Also note that an 8-Ohm speaker may be used, but the loudness will be reduced.
5. The **VLH-3000** can use the optional **MLS-300i** Intercom Speaker. This is connected to any of the Intercom terminals (“IC1” or “IC2”).
6. See Detail “A” in Figure 2, If a 2-wire speaker (such as a **MLS-300** External Speaker) is connected to the Intercom terminals (“IC1” or “IC2”), the positive wire should be connected to the center terminal and negative wire should be connected to the left-hand terminal. **Do not connect the any wire to the right-hand terminal!** If you connect one of the wires of a 2-wire speaker to a right-hand terminal, the speaker will beep continuously when turned on.
7. Put the supplied Protection Cover to the terminals to avoid a short circuit.

## 5 CONTROLS AND SWITCHES

### NOTE

This section defines each control of the Loud Hailer. See Figure 3 for location of controls. For detailed operating instructions refer to section “6 OPERATION.”

- ① **LISTEN/PWR Knob**  
Turns the **VLH-3000** on and off as well as adjusts the volume level of the built-in speaker or external speaker in the LISTEN-BACK mode.
- ② **AUTOMATIC SIGNALING Buttons**
- ③ **IC Knob**  
Adjusts the volume level of the Intercom Speaker in the INTERCOM mode.
- ④ **PA Knob**  
Adjusts the PA horn level in the HAIL or AUTOMATIC SIGNALING mode.
- ⑤ **KEYBOARD**
  - **IC 1** - Activates the Intercom Speaker 1.
  - **IC 2** - Activates the Intercom Speaker 2.
  - **PA** - Activates the PA horn.
  - **FWD** - Activates the Forward (Front) PA horn.
  - **BOTH** - Activates the both Forward (Front) and Aft (Rear) PA horns.
  - **AFT** - Activates the Aft (Rear) PA horn.
- ⑥ **DISPLAY**
  -  - Indicates the Forward (Front) PA horn is selected.
  -  - Indicates the Aft (Rear) PA horn is selected.
  -  - Steady: Indicates Intercom Speaker 1 is selected.  
Blink: Intercom 1 is calling the **VLH-3000**.
  -  - Steady: Indicates Intercom Speaker 2 is selected.  
Blink: Intercom 2 is calling the **VLH-3000**.
  -  - Indicates the PA horn is selected
- ⑦ **INTERNAL SPEAKER**  
Provides audio from intercom speakers or PA Horn.
- ⑧ **INTERCOM Buttons**
  - **IC 1** - Activates the Intercom Speaker 1.
  - **IC 2** - Activates the Intercom Speaker 2.
- ⑨ **PTT Button**  
Activates the microphone.



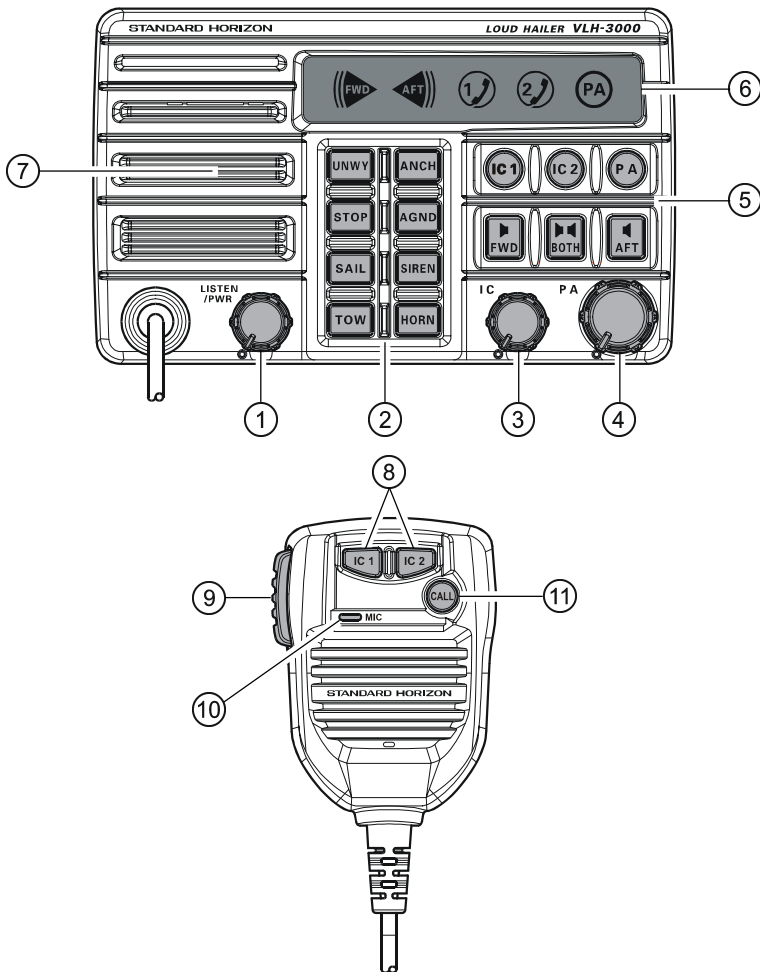

Figure 3. Controls and Switches

⑩ **MICROPHONE**

Speak into the Mic while the PTT button is press to transmit audio to the PA horn or the Intercom Speaker.

⑪ **CALL Button**

Used only when a Intercom Speaker is connected to IC1 or IC2. When pressed produces a beep in the connected Intercom Speaker.

## 6 OPERATION

This section contains operating instructions for the **VLH-3000**.

### 6.1 Switching Power On/Off

1. Rotate the **LISTEN/PWR** knob clockwise to turn on the **VLH-3000**.
2. To turn the **VLH-3000** off, turn the **LISTEN/PWR** knob fully counter-clockwise.

### 6.2 Hail/Listen-Back

1. Press the **PA** button to activate the PA horn, then select the output PA horn by pressing the **FWD**, **BOTH**, or **AFT** button.
2. Adjust the **LISTEN/PWR** knob to approximately 10 o'clock position, if necessary turn clockwise to increase the internal (or external speaker when connected) speaker volume.
3. Adjust the **PA** knob to approximately 10 o'clock position.
4. Press the microphone **PTT** button, then speak clearly with your mouth about one inch (2.5 cm) from the microphone. Rotate the **PA** knob with the **PTT** button pressed to adjust the PA horn output level. The PA horn output level can be set from 0 to 30 watts.
5. Release the microphone **PTT** button. The PA horn will automatically act as a microphone and the incoming audio signal will be heard from the built-in or external **VLH-3000** speaker. This is called Listen-Back.
6. Rotate the **IC** knob to increase or decrease the Listen-Back volume.

### 6.3 Intercom

To use the Intercom feature of the **VLH-3000**, optional Intercom Speaker are necessary. The following are available from your Dealer:

- **MLS-300i** - Intercom Speaker with PTA (Push To Alert)
1. To activate the Intercom Speaker(s), press the following keys:
    - **IC1** - to activate Intercom Speaker 1
    - **IC2** - to activate Intercom Speaker 2
  2. Make sure the **VLH-3000** is in the HAIL mode, and press the microphone **PTT** button. Speak clearly with your mouth about one inch (2.5 cm) from the microphone.
  3. To use the LISTEN-BACK mode, release the microphone **PTT** button. The activated Intercom Speaker will automatically act as a microphone and the incoming audio signal will be heard from the built-in/external **VLH-3000** speaker.
  4. Rotate the **IC** knob to increase or decrease the Listen-Back volume.
  5. PTA (Push To Alert) feature: If the **VLH-3000** in any other mode, the Intercom Speakers can alert the **VLH-3000** by pressing the **PTA** button on the **MLS-300i**. The **VLH-3000** will produce a beep to indicate a call from Intercom Station 1 of 2. At same time, “**1**” or “**2**” icon will blink. Press the corresponding intercom key to activate the Intercom Speaker. If the calling intercom speaker is already activated, the icon will light continuously.
  6. Adjust the volume of the internal/external speaker by rotating the **LIS-TEN/PWR** knob.

## 6.4 Automatic Signaling

Automatic Signaling is typically transmitted through the PA horn, but the **VLH-3000** can also send these signals to the intercom speaker(s).

1. Select the PA horn to be used by pressing the **FWD**, **BOTH**, or **AFT** button.
2. Press the one of the **AUTOMATIC SIGNALING** button to send the desired signal to the selected PA horn:

### ***Fog Horn Signaling***

**UNWY** (Underway): Sends one 5-second blasts ever 2 minutes.

**STOP:** Sends two 5-second blasts (separated by 2 seconds) ever 2 minutes.

**SAIL:** Sends one 5-second blasts followed by two 1-second blasts (separated by 2 seconds) ever 2 minutes.

**TOW:** Sends one 5-second blasts followed by three 1-second blasts (separated by 2 seconds) ever 2 minutes.

**ANCH** (Anchor): Sends one 5-second rings every 1 minute.

**AGND** (Aground): Sends one 11-second rings every 1 minute.

### ***Passing signals***

**SIREN:** Sends a varying pitch (yelping) tone while pressing the microphone **PTT** button.

**HORN:** Sends a passing signal while pressing the microphone **PTT** button.

### **NOTE**

The horn function is useful while underway to alert another vessel of your intention. A short blast is a press of the PTT for 1 second and a prolonged blast is a press of the PTT for 2 seconds:

- one short blast to mean "I am altering my course to starboard";
- two short blasts to mean "I am altering my course to port";
- three short blasts to mean "I am operating astern propulsion."

3. Rotate the **PA** knob to adjust the AF output level. The AF output level can be set from 0 to 30 watts.
4. When the Fog signal or Siren and Horn signals are not transmitted to the PA horn, turn the **LISTEN/PWR** knob to increase or decrease the listen back volume from the PA horn.
5. Press the **PA** button to disable the Automatic Signaling feature.

## FOG HORN TIMING CHART

The fog horn function sounds a horn repeatedly until the function is turned off.

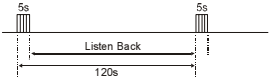
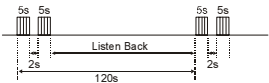
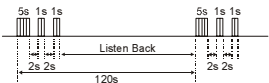
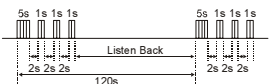
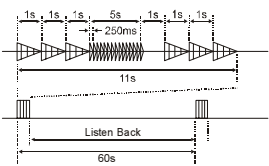
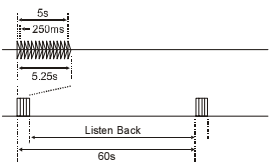
TYPE	PATTERN	USAGE
<b>UNDERWAY</b>	One 5-second blasts every 120 seconds. 	Motor vessel underway and making way.
<b>STOP</b>	Two 5-second blasts (separated by 2 seconds) every 120 seconds. 	Motor vessel underway but stopped (not making way).
<b>SAIL</b>	One 5-second blasts followed by two 1-second blasts (separated by 2 seconds) every 120 seconds. 	Sailing vessel underway, fishing vessel (underway or anchored), vessel not under command, a vessel restricted in her ability to maneuver (underway or at anchor), or a vessel towing or pushing another ahead.
<b>TOW</b>	One 5-second blasts followed by three 1-second blasts (separated by 2 seconds) every 120 seconds. 	Vessel under tow (manned).
<b>AGROUND</b>	One 11-second rings every 60 seconds. 	Vessel is aground.
<b>ANCHOR</b>	One 5-second rings every 60 seconds. 	Vessel is at anchor.

## 7 FOG ALERT TONE FREQUENCY

This section allows you to select the Alert Tone Frequency for the Automatic Signaling Operation. Available selections are “150 Hz” through “850 Hz” in 50 Hz steps. The default Alert Tone Frequency is 400 Hz.

1. Press and hold in the **PA** button while turning the **VLH-3000** on by rotating the **LISTEN/PWR** knob.
2. Blinks “**FWD**” and “**AFT**” icon and the **UNWY**, **STOP**, **SAIL**, and **TOW** buttons glows red corresponding to the current Alert Tone Frequency (see chart below).
3. Switch the **UNWY**, **STOP**, **SAIL**, and **TOW** button to the desired Alert Tone Frequency.
4. Press and hold the **PA** button for one second to save the new setting.
5. Turn the **VLH-3000** off, then turn the **VLH-3000** back on, and begin normal operation.

ALERT TONE FREQUENCY	AUTOMATIC SIGNALING BUTTON			
	UNWY	STOP	SAIL	TOW
150 Hz	Green	Green	Green	Red
200 Hz	Green	Green	Red	Green
250 Hz	Green	Green	Red	Red
300 Hz	Green	Red	Green	Green
350 Hz	Green	Red	Green	Red
400 Hz	Green	Red	Red	Green
450 Hz	Green	Red	Red	Red
500 Hz	Red	Green	Green	Green
550 Hz	Red	Green	Green	Red
600 Hz	Red	Green	Red	Green
650 Hz	Red	Green	Red	Red
700 Hz	Red	Red	Green	Green
750 Hz	Red	Red	Green	Red
800 Hz	Red	Red	Red	Green
850 Hz	Red	Red	Red	Red



## 8 MAINTENANCE

The inherent quality of the solid-state components used in the **VLH-3000** will provide many years of continuous use. Taking the following precautions will prevent damage to the **VLH-3000**.

- Keep the rear terminal strip from being directly exposed from direct water spray
- Ensure that the supply voltage to the transceiver does not exceed 16 VDC or fall below 11 VDC.
- Use only STANDARD HORIZON-approved accessories and replacement parts.

In the unlikely event of serious problems, please contact your Dealer or our repair facility. Address and phone numbers for this facility, as well as warranty information, are contained in section “**9 WARRANTY.**”

### 8.1 Replacement Parts

Occasionally an owner needs a replacement mounting bracket or knob. These can be ordered from our Parts Department by writing or calling:

#### **Marine Division of Vertex Standard**

US Headquarters

10900 Walker Street, Cypress, CA 90630, U.S.A.

Telephone (714) 827-7600

Commonly requested parts, and their part numbers are listed below.

- **Power Cord:** T9024907
- **Dust Cover:** RA0772200
- **LISTEN/PWR or IC Knob Assy:** RA0785500
- **PA Knob Assy:** RA0785400
- **Mounting Bracket:** RA0773200
- **Mounting Bracket Knob:** RA045910A
- **Microphone Hanger:** RA0458800



## 8.2 Factory Service

In the unlikely event that the radio fails to perform or needs servicing, please contact your Dealer or **Marine Division of Vertex Standard**.

An "RA" Return Authorization number is not necessary to send a product in for service. Include a brief note describing the problem along with your name, return address, phone number, and proof of purchase.

## 8.3 Troubleshooting Chart

TROUBLESHOOTING CHART		
SYMPTOM	PROBABLE CAUSE	REMEDY
Fuse blows	Reversed power wires.	Check the power cable for DC voltage, or replace the fuse (7A 250V). Make sure the red wire is connected to the positive (+) battery post, and the black wire is connected to the negative (-) battery post. If the fuse still blows, contact your Dealer.
Beeps when connecting an intercom speaker.	Incorrect intercom speaker connection.	Refer to connection diagram for proper connections.
Sound is not emitted from the external speaker.	Incorrect intercom speaker connection.	Refer to connection diagram for proper connections.

## 9 WARRANTY

### Marine Products Limited Warranty

STANDARD HORIZON (a division of VERTEX STANDARD) warrants, to the original purchaser only, each new Marine Communications Product ("Product") manufactured and/or supplied by STANDARD HORIZON against defects in materials and workmanship under normal use and service for a period of time from the date of purchase as follows:

#### Fixed Mount and Portable Transceivers

**1 year - if purchased before 01/01/91**

**3 years - if purchased between 01/01/91 and 01/01/94**

**3 years Waterproof - if purchased after 01/01/94**

#### Loud hailers

**1 year - if purchased before 01/01/91**

**3 years - if purchased after 01/01/91**

#### Associated Chargers

**1 year - if purchased before 01/01/91**

**3 years - if purchased after 01/01/91**

**Associated Batteries** - 18 months. Note: Batteries will be deemed defective only if storage capacity drops below 80% of rated capacity or if leakage develops.

**Associated Accessories** - 1 year. Includes: Microphones/Handsets, External Speakers, Antennas, Carrying Accessories, Power Supplies, and Signaling Boards.

To receive warranty service, the purchaser must deliver the Product, transportation and insurance prepaid, to STANDARD HORIZON (a division of VERTEX STANDARD). Include proof of purchase indicating model, serial number, and date of purchase. STANDARD HORIZON will return the Product to the purchaser freight prepaid. Products purchased prior to January 1, 1991 will bear the STANDARD HORIZON warranty terms in effect prior to that date.

In the event of a defect, malfunction or failure of the Product during the warranty period, STANDARD HORIZON's liability for any breach of contract or any breach of express or implied warranties in connection with the sale of Products shall be limited solely to repair or replacement, at its option, of the Product or part(s) therein which, upon examination by STANDARD HORI-

ZON, appear to be defective or not up to factory specifications. STANDARD HORIZON may, at its option, repair or replace parts or subassemblies with new or reconditioned parts and subassemblies. Parts thus repaired or replaced are warranted for the balance of the original applicable warranty.

STANDARD HORIZON will not warrant installation, maintenance or service of the Products. In all instances, STANDARD HORIZON's liability for damages shall not exceed the purchase price of the defective Product.

This warranty only extends to Products sold within the 50 States of the United States of America and the District of Columbia.

STANDARD HORIZON will pay all labor to repair the product and replacement parts charges incurred in providing the warranty service except where purchaser abuse or other qualifying exceptions exist. The purchaser must pay any transportation expenses incurred in returning the Product to STANDARD HORIZON for service.

This limited warranty does not extend to any Product which has been subjected to misuse, neglect, accident, incorrect wiring by anyone other than STANDARD HORIZON, improper installation, or subjected to use in violation of instructions furnished by STANDARD HORIZON, nor does this warranty extend to Products on which the serial number has been removed, defaced, or changed. STANDARD HORIZON cannot be responsible in any way for ancillary equipment not furnished by STANDARD HORIZON which is attached to or used in connection with STANDARD HORIZON's Products, or for the operation of the Product with any ancillary equipment, and all such equipment is expressly excluded from this warranty. STANDARD HORIZON disclaims liability for range, coverage, or operation of the Product and ancillary equipment as a whole under this warranty. STANDARD HORIZON reserves the right to make changes or improvements in Products, during subsequent production, without incurring the obligation to install such changes or improvements on previously manufactured Products.

The implied warranties which the law imposes on the sale of this Product are expressly LIMITED, in duration, to the time period specified above. STANDARD HORIZON shall not be liable under any circumstances for consequential damages resulting from the use and operation of this Product, or from the breach of this LIMITED WARRANTY, any implied warranties, or any contract with STANDARD HORIZON. IN CONNECTION WITH THE SALE OF ITS PRODUCTS, STANDARD HORIZON MAKES NO WARRANT-

TIES, EXPRESS OR IMPLIED AS TO THE MERCHANTABILITY OR FITNESS FOR A PARTICULAR PURPOSE OR OTHERWISE, EXCEPT AS EXPRESSLY SET FORTH HEREIN.

Some states do not allow the exclusion or limitation of incidental or consequential damages, or limitation on how long an implied warranty lasts, so the above limitations or exclusions may not apply. This warranty gives specific legal rights, and there may be other rights which may vary from state to state.

ONLY PRODUCTS SOLD ON OR AFTER JANUARY 1, 1991 ARE COVERED UNDER THE TERMS OF THIS LIMITED WARRANTY.



## ON-LINE WARRANTY REGISTRATION

THANK YOU for buying STANDARD HORIZON (a division of Vertex Standard) products! We are confident your new radio will serve your needs for many years!

Please visit [www.standardhorizon.com](http://www.standardhorizon.com) to register the QUEST Marine VHF. It should be noted that visiting the Web site from time to time may be beneficial to you, as new products are released they will appear on the STANDARD HORIZON Web site. Also a statement regarding product support should be added to the manual.

### Product Support Inquiries

If you have any questions or comments regarding the use of the **VLH-3000**, you can visit the STANDARD HORIZON Web site to send an E-Mail or contact the Product Support team at (714) 827-7600 ext 6300 M-F 7:00-5:00PST.

In addition to the warranty, STANDARD HORIZON includes a lifetime "flat rate" program to provide service after the warranty period has expired. If you wish to obtain the flat rate price for out-of-warranty repair, you must include the information on the Owner's Record with the unit when you return it to your Dealer or to STANDARD HORIZON.

Lifetime Flat Rate Service Program: For the original Owner only, for the lifetime of the unit, STANDARD HORIZON will repair the unit to original specifications.

Note: The flat rate amount is payable by the Owner only if STANDARD HORIZON or the STANDARD HORIZON Dealer determines that a repair is needed. After the repair, a 90-day warranty will be in effect from the date of return of the unit to the Owner.

This service program is not available for equipment which has failed as a result of neglect, accident, breakage, misuse, improper installation or modification, or water damage (depending on the product).

## 10 SPECIFICATIONS

Input Voltage .....	13.8 VDC $\pm$ 20%
Maximum Current .....	8 A
Operating Temperature Range .....	-4 °F to +140 °F (-20 °C to +60 °C)
Storage Temperature Range .....	-22 °F to +158 °F (-30 °C to +70 °C)
Water Integrity Performance .....	IPX7 (3 ft for 30 min) for the front panel
Dimensions .....	4.3" H x 7.1" W x 5.5" D (110 H x 180 W x 140 D mm)
Flush-Mount Dimensions .....	3.6" H x 6.5" W x 4.5" D (92 H x 165 W x 115 D mm)
Weight .....	2.97 lbs (1.35 kg)
Microphone Impedance .....	2 k $\Omega$
Microphone Sensitivity .....	10 mV
Speaker Impedance	
Internal Speaker .....	8 $\Omega$
External Speaker .....	4 $\Omega$
Intercom Speaker .....	4 $\Omega$
PA Horn .....	4 $\Omega$
Maximum Output Power	
Internal Speaker .....	2.0 Watts (@8 $\Omega$ , 10 % distortion)
External Speaker .....	4.0 Watts (@4 $\Omega$ , 10 % distortion)
Intercom Speaker .....	4.0 Watts x 2 CH (@4 $\Omega$ , 10 % distortion)
PA Horn .....	25 Watts x 2 CH (@4 $\Omega$ , 10 % distortion)
Fog Horn Frequency .....	150 - 850 Hz (Adjustable, 50 Hz multiple)

*Standard Horizon reserves the right to make changes and enhancements to products at our discretion. Current specification are therefore subject to change without notice.*





**Marine Division of VERTEX STANDARD**

**US Headquarters**

10900 Walker Street, Cypress, CA 90630, U.S.A.

[www.standardhorizon.com](http://www.standardhorizon.com)



E M 0 2 0 X 1 0 0

Copyright 2006  
VERTEX STANDARD CO., LTD.  
All rights reserved.

No portion of this manual  
may be reproduced  
without the permission of  
VERTEX STANDARD CO., LTD.